



# THE PEARL

## PI LAMBDA PHI FRATERNITY

*"That all men are created free and equal.*

*That no society of men can flourish unless members of that society are endowed with the opportunities and privileges of freedom.*

*That freedom implies the elimination of prejudice — that the elimination of prejudice means a better understanding twixt men.*

*That it is incumbent upon me to fight for such freedom even with my life.*

*That it is incumbent upon me in my personal life to be devoted to the highest standards of honesty and justice.*

*That because my country is dedicated to the highest standards of freedom and justice for all men of all creeds, I hereby pledge allegiance to my country, and to its national symbol."*

University of Florida Volume XVIII

NINETEEN HUNDRED SEVENTY THREE

*The Brothers of The Florida Chapter  
Solemnly Dedicate This Journal to The Memory Of*

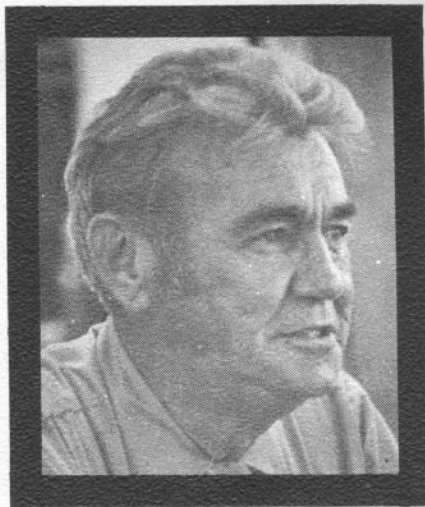

## Brother Frederick Jones

### DEDICATION

The Brothers of the Florida Delta Chapter of Pi Lambda Phi Fraternity solemnly dedicate this journal to the memory of

### *BROTHER FREDERICK JONES*

Devotion to the fraternity takes many roads and comes from many sources. For five years Fred Jones worked diligently towards the building of a firm financial foundation for Pi Lam. Yet to Fred this became more than a job and his efforts more than a common labor. Fred became a friend to all the brothers and his words of advice were always filled with a sense of spirit that was a source of constant inspiration to the chapter.

For his devotion we bestowed the rights of brotherhood upon him and he always spoke proudly of them. Death claimed Brother Jones in 1972 and Florida Delta mourns his loss. He was an advisor, a friend, and a brother; one whom we proudly called a Pi Lam.



# THE PEARL

1973  
NUMBER XVIII

## CONTENTS

- 1 The Creed
- 2 Dedication
- 3 Staff & Contents
- 4 Letter From the Rex
- 5 Letter From the Editor
- 8 Scholarship
- 10 Brotherhood
- 11 Service For A Better Life
- 12 Athletics
- 15 Two Share Best Sr. Athlete
- 16 Little Sisters
- 18 Lammies At Their Best
- 20 Pledge Class '72
- 22 Nose Trophy Returns
- 24 Best Freshman and Senior
- 25 Farewell to Seniors
- 28 Campus Leaders
- 30 Our Gang
- 32 Lovers & Other Strangers
- 34 Pledgemaster Speaks
- 35 Support our Advertisers
- 58 People
- 61 Pi Lam Roster

## STAFF

**ROBERT D. KLAUSNER**  
*Editor-in-Chief*

**EDWARD SOLOMON**  
*Photography*

**BRUCE KLEINBERG**  
*Advertising Manager*

**EVAN BYER**

**RICK GILMAN**

**MINDY KLEIN**

**JOEL MANIS**

**JUAN SOSTHEIM**

*Contributors*





# LETTER FROM THE REX

The experience of coming to college will probably be one of the most rewarding experiences in your life. The education and knowledge you attain cannot be duplicated through any other process. However, a large portion of this knowledge cannot be reached through books and hard studying; it can only be experienced through your interactions with others. Whether these interactions be through scholastics, athletics, or social, they are the key to maximizing your college experience.

It was through this understanding that fraternities were created in the first place. In keeping with this, in 1895, at Yale University, Pi Lambda Phi was founded, and was established as a non-discriminatory fraternity devoted to the concept that neither race, creed, nor color should be a consideration for membership.

The men of Pi Lambda Phi have always upheld the traditions of leadership and good character, but more important than this, we have held true to the ties which have always been the ideal of our brotherhood.

The men of Pi Lambda Phi extend to you an open invitation to come by and get acquainted, and perhaps we can share that true brotherhood is all about. To all those who will someday wear the pin of our order, I wish for you to leave one day with the same good feelings and satisfaction I leave with now. After many good times and four hard years, I sincerely thank you.

Fraternaly yours,

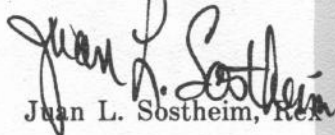
  
Juan L. Sostheim, Rex





## LETTER FROM THE EDITOR

Dear Readers,

You hold in your hands the eighteenth edition of the PEARL. It is an essay in words and pictures presenting the latest chapter in the ever-changing and continuing life of Pi Lambda Phi.

To the brothers to whom this publication pays tribute, it is a kaleidoscope of precious memories. Recorded on its pages are the events of one year of our lives.

For the rushee, the PEARL is a window to the world of Pi Lam. Between its covers is our simple story and an invitation to further explore the fraternal life.

Lastly the PEARL is a financial venture. Because of continued support from alumni and friends, the PEARL contributes substantially to Pi Lambda Phi's firm financial foundation.

The PEARL is the oldest, largest, and most widely circulated fraternal publication at UF. As editor for the second time, I can honestly say that through the PEARL I have become more keenly aware of the strength and diversity of our order.

I hope that you will read the following pages carefully and see for yourself, the friendship and brotherhood that is the Pi Lambda Phi experience.

Fraternally yours,

*Robert D. Klausner*

Robert D. Klausner

# Paul Marks: Pi Lam's Voice of Experience

In the search for a better path to the future, it is always wise to seek advice from the experienced past. One individual stands far above the rest as a source of sound counsel. Brother Paul Marks has for more than forty years served as a model of Pi Lam brotherhood and devotion.

Be it in the area of house improvements, summer rush, or relations with alumni, Paul Marks has never ceased his tireless efforts for Florida Delta. For his continued concern, Brother Marks has been the recipient of the National Council Key, the coveted Big Pi Award, a Florida Blue Key, and was named Outstanding National Alumnus by the National Convention.

Brother Marks' activities range far beyond the scope of the fraternity. In Miami, where he is a well-known civic leader, Mr. Marks is Chairman of the Board of the Flagler Federal Savings and Loan. In addition, he has been an active member of the UF Alumni Club and the Executive Committee of the Orange Bowl.

Whether talking about business, civic affairs, or the welfare of the fraternity, Paul Marks has distinguished himself and brought credit to Pi Lambda Phi.

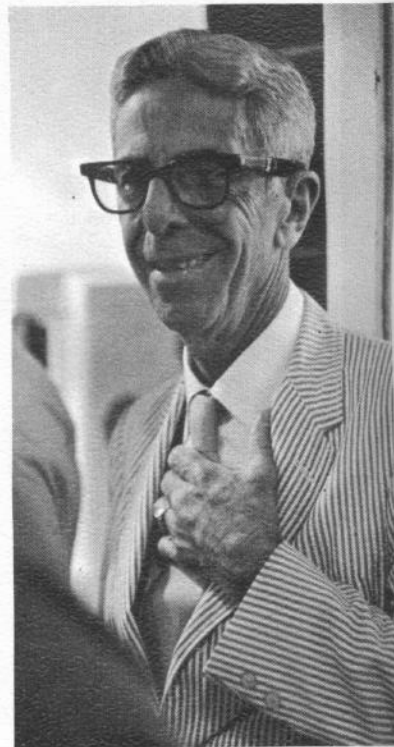

# Dr. Stephen Feinstein: Our New Guiding Hand

It has always been the hope of the chapter to have firsthand advice from past brothers. This year Pi Lam was privileged to obtain as its faculty advisor, Dr. Stephen Feinstein (Delta '59). Brother Feinstein, a native of Jacksonville received his Ph.D. in Experimental Psychology and is presently working in the Communications Sciences Laboratory of the Department of Speech.

Brother Feinstein's enthusiasm has quickly earned him the admiration and respect of the active brothers. Florida Delta welcomes back its brother and looks forward to much progress working together in the years to come.



## BYRON SALTER, Financial Advisor

When it comes to matters of high finance, Pi Lam turns to its trusted accountant Byron Salter. A member of the University of Florida staff, Mr. Salter is serving his first year as financial advisor to the chapter. His friendly smile and sound advice have quickly made him a welcome part of the growing Pi Lam family.

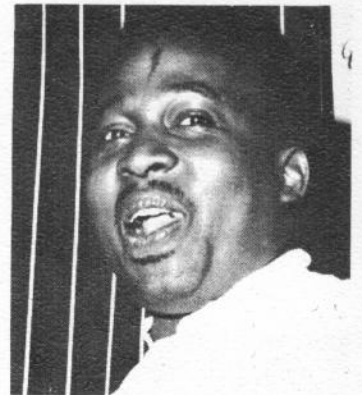

## Scotty, Louise, and LeRoy

Appreciation is a relative term. When used in reference to Pi Lam's friendly employees, appreciation cannot ever be as fully expressed as it is felt.

Keeping the Pi Lam house clean is a most difficult task. But, for the past 20 years LeRoy Tillman has kept the fraternity's residence in perfect order. LeRoy began working for Pi Lam when we still maintained a house on University Avenue. When the fraternity made its move to the Row, LeRoy came too. With two decades of Pi Lam spirit behind him LeRoy is a familiar member of Pi Lam's "family".

Feeding the hungry masses is a fulltime job in Pi Lam. Whether it be Saturday brunch or a Rush Week steak dinner, the brothers are assured of getting the very best from chef Durant Scott. Aided by his wife Louise, Scotty keeps the kitchen budget in balance. Yet, more than a cook, Scotty is a friend to the Brothers. Playing pool or just rapping, Scotty displays a real interest in the welfare of the brothers.

# PI LAMBS ARE TOP SC



Ronald Blumstein

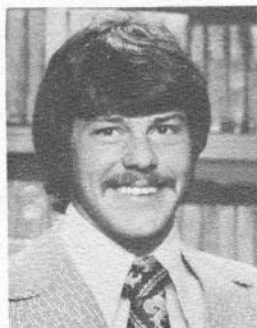

Juan Sostheim

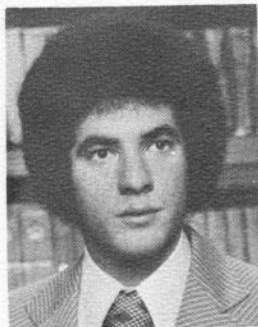

Robert Klausner



Steve Messing

For nearly half a century, Pi Lambda Phi has been the undisputed leader in academics at the University of Florida. This year was no exception as the Lammies again captured the overall scholarship crown.

Formost in the effort are those with highly respected mark of perfection, the 4.0. Bringing home the laurals for the house were Stu Suskin, Steve Messing, Ron Blumstein, John Smith, Howard Sokol, Steve Sultanoff, Rick Blau, Peter Ciporkin, and Tom Rosenfield. For their academic excellence, each was named to the President's Honor Roll.

Many other brothers contributed to the long standing record of Pi Lam. They are Dave Weiner (3.9), Evan Byer (3.8), Harvey Kornstein (3.8), Mike Halprin (3.8), Gordon Brydger (3.8), Bob Klausner (3.8), and Roger Wenner (3.8). Close on their heels were Juan Sostheim (3.7), Jeff Hochman (3.7), Howard Farbish (3.6), Dave Tillis (3.6), and Steve Seidler, Mark Michelson, Scott Lyons, and Ira Gordon all with 3.5.

Consistently making over the venerated mark of 3.0 are Rick Adelman, Tony Salzman, Joel Manis, Rick Gilman, Bruce Kleinberg, and Joe Jacoby. They are joined by Bill Lawrence, Rick Goldberg, George Lipp, Sammy Slom, Allen Eckloff, and Barry Meyerson.

The new brothers also distinguished themselves in the difficult first year. Roland Farris led with a 3.5. He was followed closely by Sandy Chisholm (3.4), Dan Aaronson (3.4), and Tony Ozell (3.4).

Brother Mike Rosin was named to the exclusive Phi Beta Kappa Honorary last Spring, while graduating summa cum laude. Along with Mike in various medical schools are Steve Rokeach, Bill Kaufman, Mark Shamis, and Larry Lewis. Heading for legal careers are Carl Lida, Bob Bogen, Barry Silber, Bob Maland, Jeff Hirsch and Shelly Stevens.

Sporting the only fraternity average above 3.0, Pi Lam once again captured top honors for the Greek system. Recognizing their primary responsibility, the Lammies proved that along with sports and social, they are *the* leaders in the classroom.



Howard Sokol



Roger Wenner



Stuart Suskin



Gordon Brydger

# SCHOLARS FOR 72-73



*Peter Ciporkin*



*David Weiner*



*Sandy Chisolm*



*Harvey Kornstein*



*Richard Blau*



*Evan Byer*



*Mike Halprin*



*OUR PRIDE AND JOY*



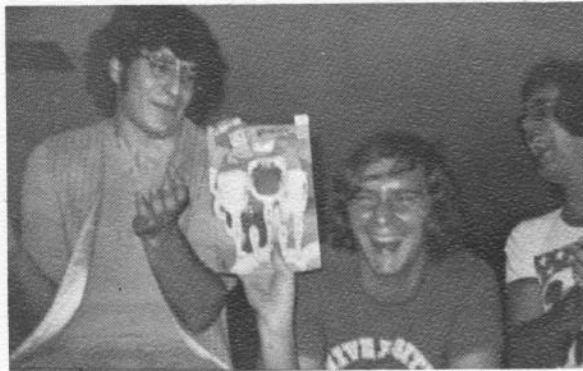
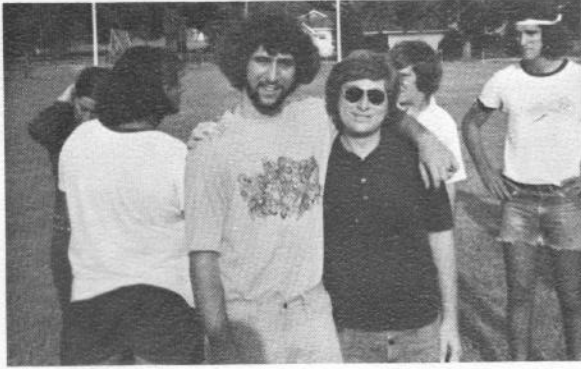

## BROTHERHOOD:

# The Spirit of Trust and Confidence

The ultimate, yet often intangible goal of fraternalism is brotherhood. It is a kind of unspoken bond that makes strangers into brothers and acquaintances into life-long friends. It is this spirit of mutual trust and friendship that makes Pi Lambda Phi more than a fraternity, but rather a way of life.

From the moment that a pledge first signs the Lambskin until he pins on the badge of brotherhood, he is treated like an individual. Gone are the days when pledges were subject to the whims of the brothers. Instead, the ideals of Pi Lambda Phi brotherhood are the outgrowth of friendship, as the period of pledgship has evolved into one of fraternity education.

The smiles, the warm handshakes, and the air of confidence are not merely a pretense seen only during rush. Rather, this expression of solidarity lives and grows every day. This unity of effort is seen in the closeness surrounding the Nose Bowl, at the solemn rites of initiation, and most importantly in the living experience that is the strength of the house.

After a pledge becomes a brother he has a fuller understanding of the essence of our order. The enthusiasm of pledgship continues not only through college, but into later life as well. The lasting friendships formed in Pi Lam and the devotion of hundreds of alumni are proof of the eternal nature of our brotherhood.

Pi Lambda Phi has stood the test of time and shown itself to possess this priceless sense of brotherhood. As our motto suggests, ideals that have created and preserved our fraternity are "not just for four years, but a lifetime."

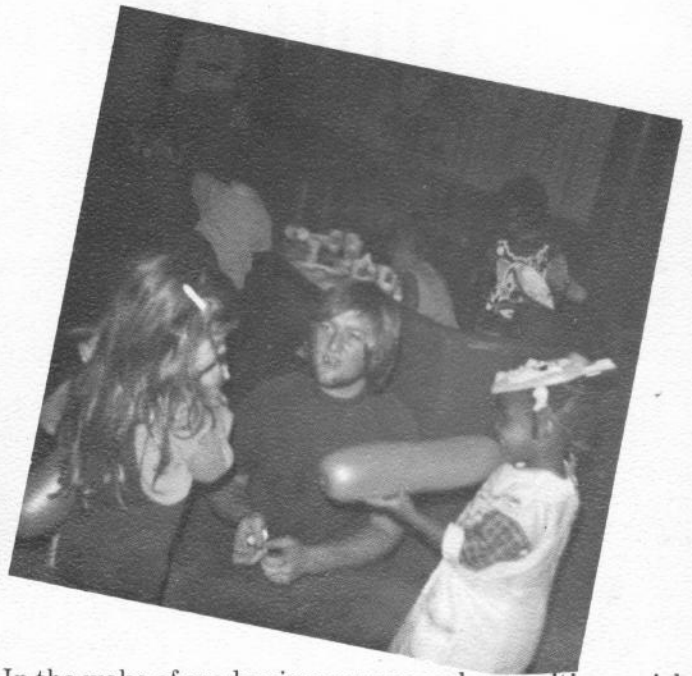
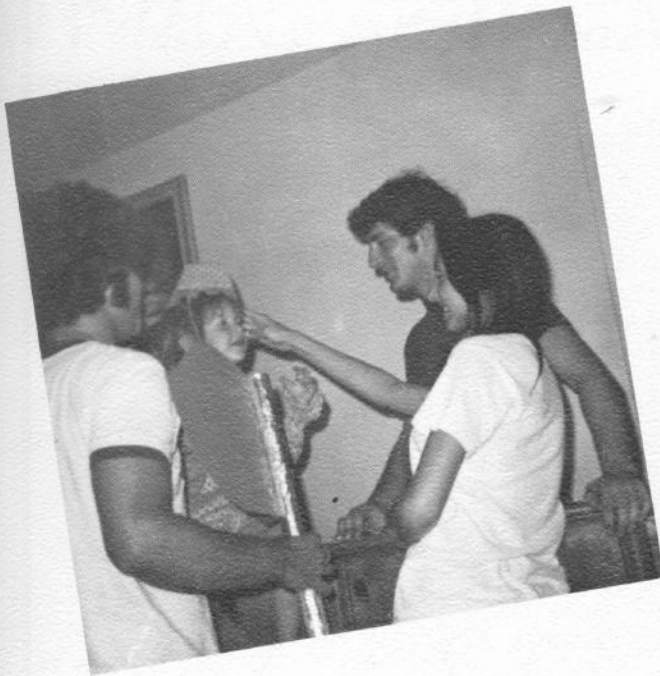

In the wake of academic pressure and an exciting social atmosphere, the college student too often forgets the problems of the outside world. Such is not the case with Pi Lams, as numerous brothers can be found in a myriad of community endeavors.

## SERVICE:

# Pi Lams Work For a Brighter Tomorrow

The most important service project is the annual Pi Lam-Delta Phi Epsilon Halloween Party. This year, as in the past, the Deepfers and Lammies played host to nearly fifty children from local foster homes. This year's "Haunted Happening" featured an afternoon of cake, ice cream and "Trick or Treat" candy. For the kids, it was a day to remember. For the brotherhood, led by Service Chairman Jeff Hochman, it was a chance to help make a child's life a little happier.

In the Spring, Juan Sostheim, Dennis La Roche, and Bob Klausner represented the house in the IFC Blood Drive. The Pledge Class of '72 served in the campus' annual United Fund Drive, held every October this drive benefits some 40 charities.

As individuals, brothers directed their efforts in many directions. Brothers Mark Michelson and Evan Byer tutored underprivileged children in local schools. Joe Jacoby devoted many hours of time to the United Jewish Appeal. Rick Gilman and Howard Sokol walked 20 miles in the Cerebral Palsey Walk-A-Thon.

Besides the social and academic side of campus life, Pi Lams also recognize their responsibility to the community at large. When the need arises, Pi Lams will answer the call. Where no solution exists, we will find one.

# ATHLETICS: LAMMIES CLAIM TW

Consistency was the key word in Pi Lam athletics this year. In the quest for the coveted President's Cup, the Lammies made great strides toward this goal with impressive victories in volleyball and racquetball.

Swimming began the long list of sports. Mike Halprin led the team with a fine showing in the finals of the fifty-yard freestyle.

Volleyball followed and brought Pi Lam its first trophy of the season. Paced by the superb team of Rick Goldberg, Barry Meyerson, Sheldon Sager, Rick Adelman, Louis Lippman, and Mark Michelson, the Lammies ended the exciting play in a three-way tie with PiKA and Phi Kappa Tau. Juan Sostheim and Peter Ciporkin also provided spirited play to the effort.

The final sport of the first quarter was football and the Lammies again posted an impressive record. Sparking the offense were Bob Schack, Barry Meyerson, and Eddie Sager. Leading the defensive effort in Pi Lam's two victories in three starts, were Jim Elterman and Nick Aradi.

For the Orange League leading Pi Lams, racquetball provided a thrilling beginning to the second quarter. With a dramatic 3-2 victory over ATO in the finals, Pi Lambda Phi gained its second sports crown of the season. Rick Adelman, Louis Lippman, and Steve Seidler were standouts in singles play. The doubles action was led by Harvey Kornstein, Joel Meyer, Nick Aradi, Rick Goldberg, Juan Sostheim, Leon Azis, and Paul LeWinter.

The bowling squad, captained by Rick Gilman, narrowly missed another championship in a close battle with SAE. Terry Forman, Mike Plasker, Barry Meyerson, and Rick Goldberg comprised the squad.

On the basketball court, Pi Lam continued its winning ways. Captain Mark Michelson, backed by Meyerson, Goldberg, and Ken Keyser led the team to victories over Sigma Chi and Lambda Chi.

Before bowing in a close match in the bracket finals, Juan Sostheim paced the team of Gary Schuler, Louis Lippman, and Rick Adelman to a fine showing in handball. Such consistent efforts found Pi Lam still very much in contention for the President's Cup going into the Spring.

Golf began the quarter with Gary Schuler, Ken Keyser, and Stan Halpern burning up the links. A fine showing was made by the always potent tennis squad. Lou Lippman, Nick Aradi, and Rick Goldberg turned in outstanding singles play. A strong performance in doubles was made by Mike Plasker, Steve Sultanoff, Josh Rodstein, and Pete Ciporkin.

With track and softball still undecided, Pi Lam still remains high in the standings. With a strong showing in virtually every sport, 1972-73 saw Pi Lambda Phi as an athletic power to be reckoned with.



*Elterman on an interception return.*

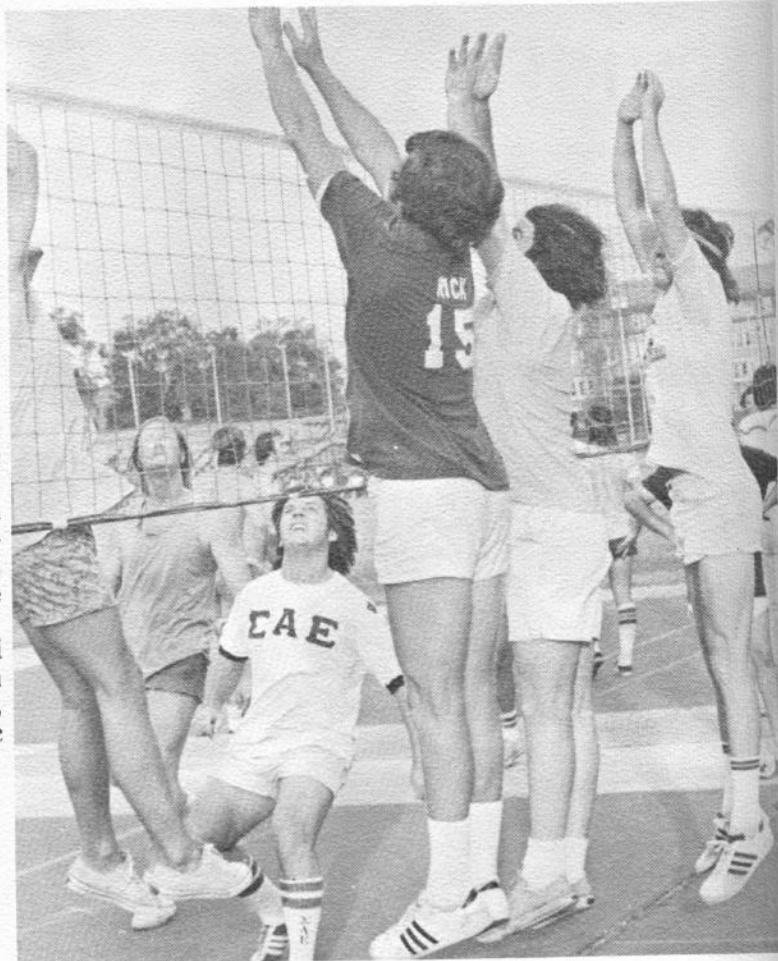

*Three big reasons why the Lammies won volleyball stuff the SAEs.*



# ORANGE LEAGUE CROWNS

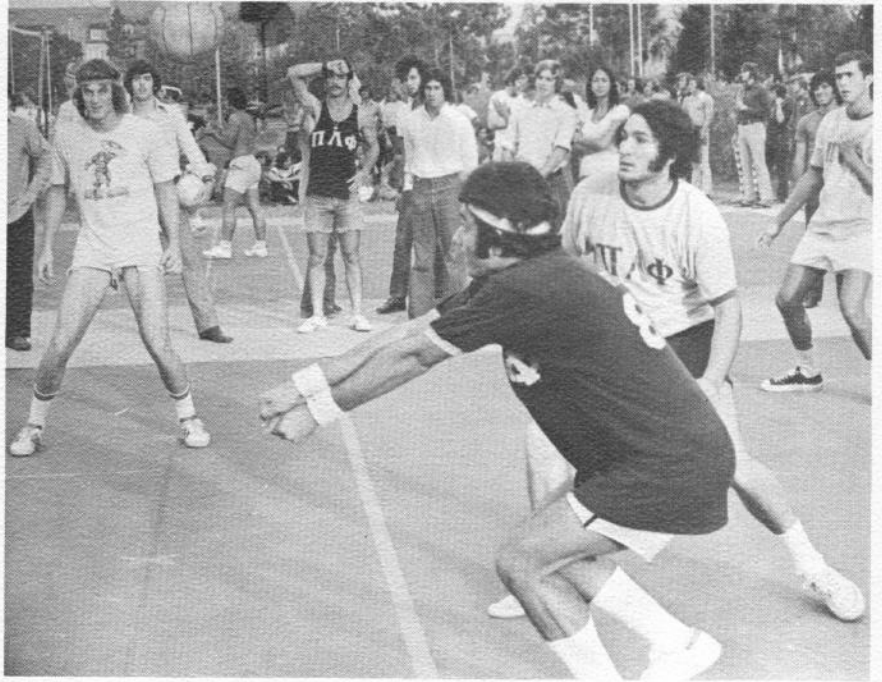
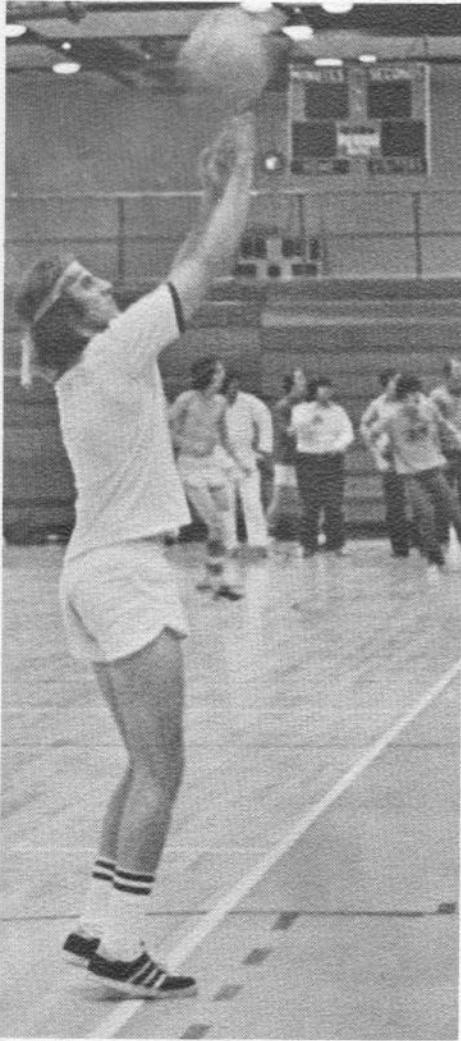

*Peter Ciporkin's moment of glory*

*If you're looking for a snappy caption, forget it! This is Mark Michelson...*

*Goldberg shuffs SAE again!*



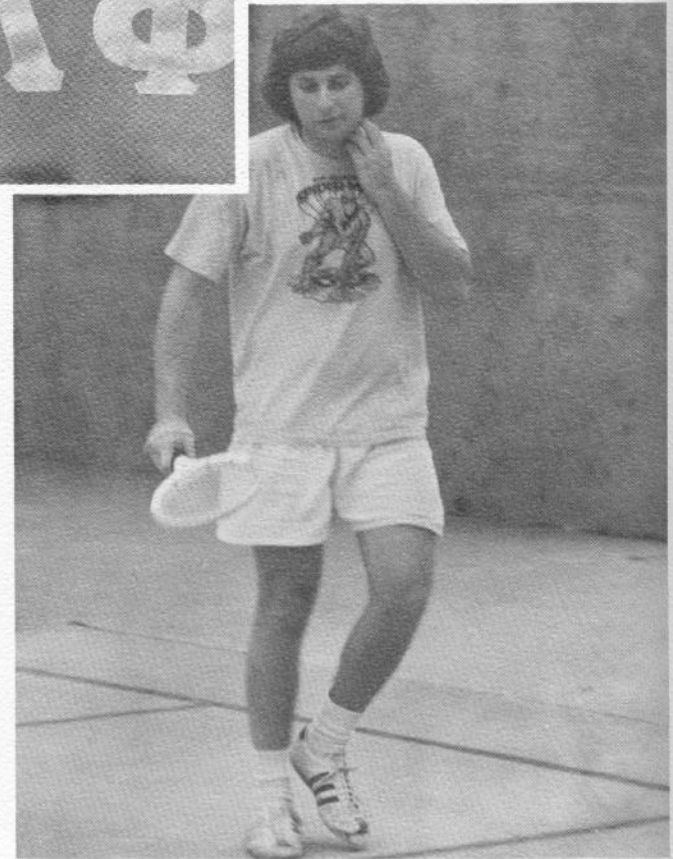
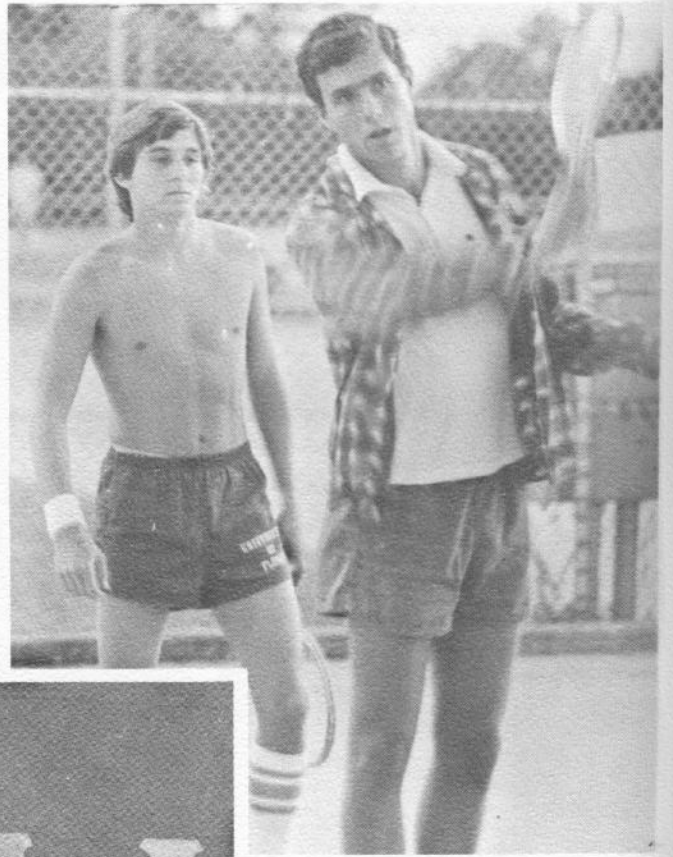
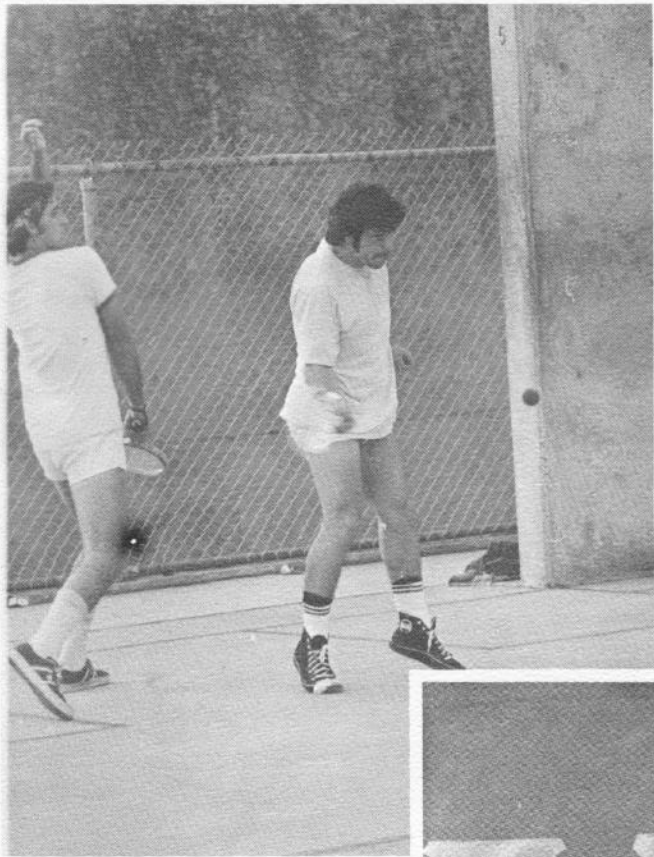



# TWO SHARE BEST SENIOR ATHLETE FOR 1972-73

As any athlete knows ability and spirit are the key factors to success in sports. For this reason the brotherhood chose to honor Rick Goldberg and Glenn Tobin as Best Senior Athletes.

Rick's contributions to Pi Lam athletics are almost without number. As a freshman he led his pledge team to a sparkling triumph in the 1969 Nose Bowl. Since then Goldberg has made his mark in volleyball, football, racquetball, basketball, tennis, softball, and track. As a result Rick's name appears on numerous championship trophies.

Never has more devotion to the spirit of sportsmanship been displayed than by Glenn Tobin. Coach Tobe has lent his strong voice and infinite knowledge of sport to countless Pi Lam athletic endeavors. His enthusiasm provided the winning spark in more than one sports contest.

Spirit and ability; an unbeatable combination. Rick Goldberg and Glenn Tobin; an incomparable duo.

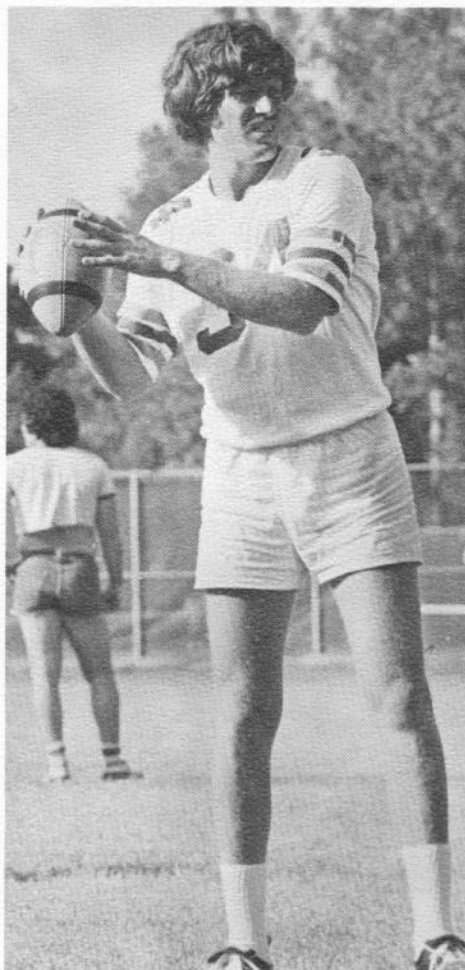

*Rick Goldberg*



*Glenn Tobin*



## *Little Sisters: The Beauty of A Growing Friendship*

It has been said that no smile is as warm as that of a pretty woman. This year Pi Lam was warmed by the glow of nineteen such smiles as the Little Sisters completed their second year.

The gifts that the Little Sisters give the house are almost beyond number. In Fall Rush, their charm and personality gave an immeasurable boost to the efforts of the brothers. During Nose Bowl Week the Little Sisters covered the house with signs and slogans and were seen cheering the pledges on to victory.

Beyond the parties, Tuesday dinners, and rush, the Little Sisters added a good deal more. When the advice that only girls can give was needed, they were there with the desire to listen. When spirits lagged, the Little Sisters could always be counted upon to brighten up the house.

As strangers in an all-male environment, the Little Sisters were soon adopted by the brotherhood. In return, they gave a more relaxed and happy atmosphere to the fraternity.

Still in its infancy, the Little Sister program has come far in overcoming the uncertainties that are found in any new enterprise. Yet the spirit, love, and devotion to Pi Lam displayed by the Little Sisters has earned the everlasting affection and gratitude of the brotherhood.



*Thanks! We Needed That.*



Row 1 (L to R) — Tracey Davidson, Carol Sokolow, Carol Breitenbucher, Lisa Markowitz, Mindy Klein, Teri Pizzulo, Susie Feldman, Susan Arnovitz.  
Row 2 (L to R) — Debbie Rubin, Margie Gelber, Wendy Lester  
Row 3 (L to R) — Laurie Coleman, Lynn Rubin.

*Tuesday's Child Is Full of Grace . . .*



*Goldie*



*Terri*

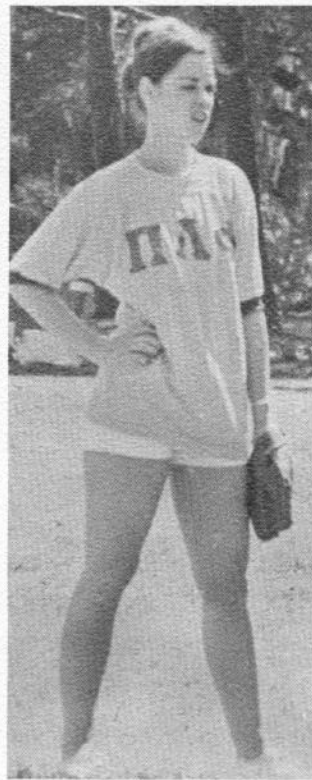

*Laurie*



*Lisa*



*Santa Wendy*

# Social: The Lammies at Their Best



*Schuler receives Swiss Cheese Award at Christmas Party.*

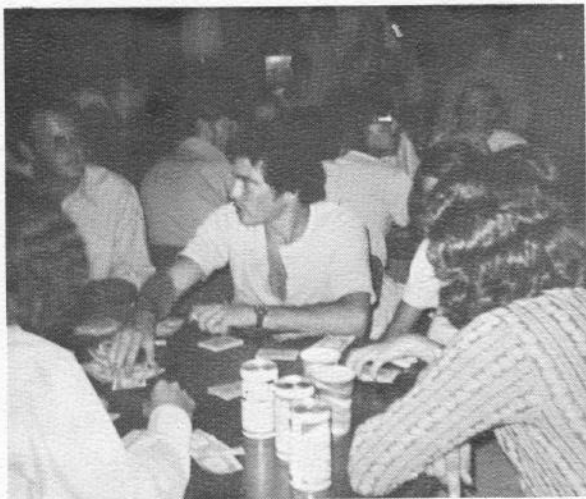

*Casino Night highlighted rush activities.*



*Little Sister nights always were good for some laughs.*

The 1972-73 school year has shown why Pi Lambda Phi's social calendar at the University of Florida is the best.

Guided by Social Chairmen Flip Schemer, Steve Diamond, and Joe "Mad Dog" Jacoby an unsurpassed year of entertainment was enjoyed by the brothers of Florida Delta.

The social program was highlighted by band parties, sorority socials, movies, pizza parties, and roller derby parties "Eli", "Mudcrutch", and "Southern Comfort" were just three of the great bands entertaining the Lammies and their dates.

We were pleased to entertain two sororities this year at the house. First quarter saw the AEPHI's enjoying a pizza and beer party. The Lammies extended their hospitality second quarter to the D PHI E's for one of our famous wine & cheese socials.

Pi Lam movie parties catered to such sellouts as W. C. Fields and The Three Stooges. Skating Palace was the site of our newest innovation, a roller derby party that was thoroughly enjoyed.

Two nights of non-stop entertainment awaited our parents this year at Parents' Weekend. In addition to getting a look at their sons again, they were treated to a memorable time.

High School Weekend was a great success. A party with the Little Sisters and a concert by the fabulous Jimmy Spheeris highlighted this annual event.

Our last big social event of this year is Pearl Weekend. This month the house will be boogeying to the sounds of "Catarro" and looking forward to a day of sun and surf on St. Petersburg Beach.

These are just a few of the reasons why Pi Lam is the social trend-setter and a leading social house in the fraternity community.



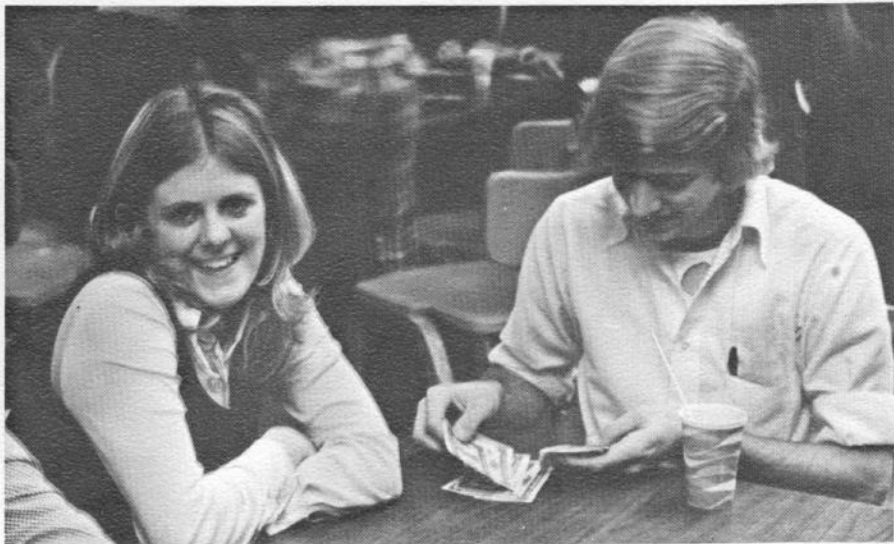

# PLEDGE CLASS '72:

## THE HOPE OF THE FUTURE

Spirit and dedication are the words that best exemplify the newest members of Pi Lambda Phi. The Pledge Class of '72 displayed a unity of effort that was once believed to be a thing of the past.

The Baby Lammies were quick to enter the mainstream of house life. Under the guidance of Pledgemaster Sammy Slom, the pledges excelled in every undertaking. Among the list of long-standing traditions upheld by the '72 brothers-to-be was the celebrated "Irish Spaghetti Festival," educating Roger in the arts of nocturnal hiking, and bringing the Nose Bowl trophy back home.

For his excellent academic showing, Roland Farris was tapped for membership in Phi Eta Sigma. New brother Tony Ozell took an active part in the student body elections, while Stuart Sachs distinguished himself in the technical department of the Florida Players. Pledge Class President Ed Carter added the musical touch as a member of the UF Concert Band.

In athletics, the new brothers seemed to be everywhere. In swimming, Nick Aradi made an excellent showing and when football season arrived teamed up with his brother George. Josh Rodstein and Steve Sultanoff paced the tennis squad and Gary Schuler added a big spark to the golf and handball squads.

When it came to house activities, the Pledge Class of '72 was everywhere. Victor Alonso and Dan Aaronson began the chapter's alumni newspaper. Ozell and Rodstein served as Co-Chairmen of High School Weekend. Dennis LaRoche accepted the task of Lawn Manager.

With their sense of devotion to each other and to Pi Lam, the new Lammies admirably passed the rigors of "Hell Week" and were granted the rights of brotherhood. First as pledges and now as brothers, the Class of '72 provide inspiration and hope for the future.



*Fishkind signs the Lambskin as excited brothers applaud.*

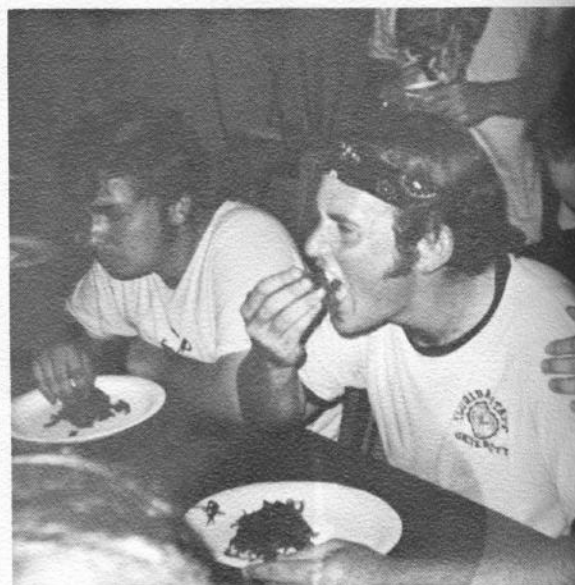

*Radar Jacoby homing in on the "pledges' delight".*



WHAT MAKES



A

PI LAM PLEDGE?

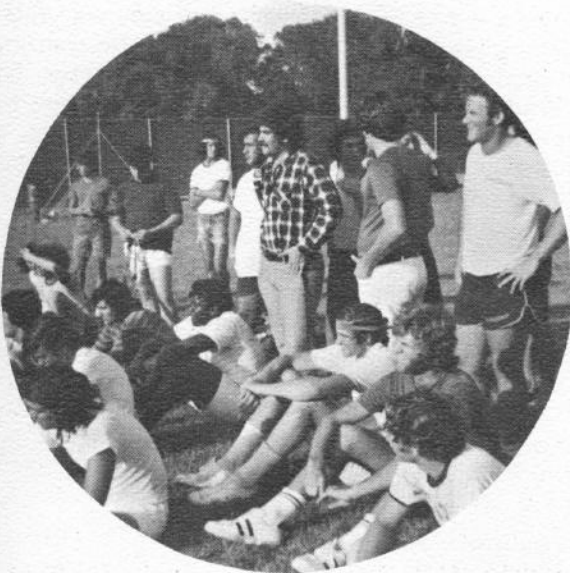



# PLEDGES SPARKLE IN NOSE BOWL TRIUMPH

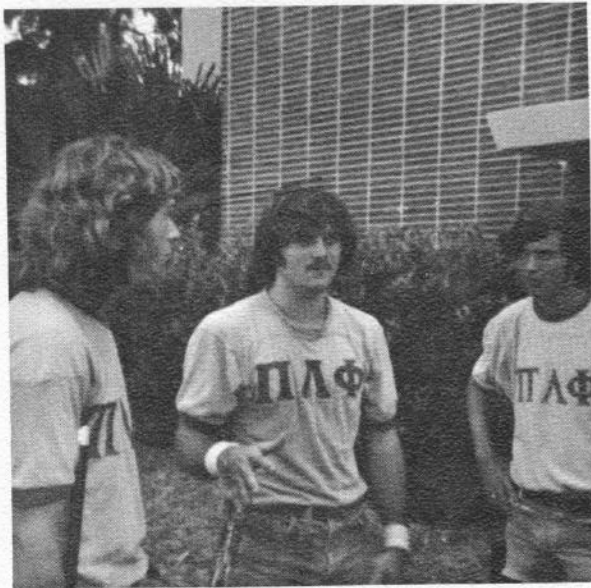

*Anxious faces reflect pre-game thoughts*



*Victory is Ours*

The Nose Bowl: more than any other single event in a pledge's life, those three words symbolize the unity of effort and spirit of Pi Lam. With the sting of 1971 still fresh in the memory of the brothers, the Baby Lammies returned the Nose Bowl crown to Pi Lam in an exciting 12-6 overtime victory over arch-rival TEP.

The week preceeding the game was filled with constant excitement as the brothers worked to bring the pledges to a fighting peak. Even the Little Sisters joined the spirit of the contest by covering the entire house with victory signs.

In the contest, held at Westgate Park, the first half proved to be a defensive battle. Neither side was able to get within scoring range. The scoreless battle continued into the final quarter, when Lammies quarter back George Aradi scampered 15 yards for the games first TD. Following an unsuccessful point after attempt, the TEP's took over the ball. With only seconds remaining, a deflected pass was hauled in by the TEP's to tie the score.

The game was then thrown into a sudden-death overtime situation, with the team moving the ball the farthest in four downs to be declared the winner. TEP was on the offense first and superb defense play held them to a mere twelve yards. The Lammies took over and on first down, George Aradi dashed for eight yards. On the next play George flipped a quick pass to Nick Aradi, who then moved untouched into the end zone for the winning score.

Starters on offense were George Aradi — Offensive Captain, Nick Aradi, Gary Schuler, Vic Alonso, Josh Rodstein, Steve Sultanoof, and Joe "Gator" Jacoby. Stalwarts on defense were Ron Fields, Alan Stein, Herb Zelikoff, Paul LeWinter, Sandy Chisholm, Ron Fields, Nick Aradi, and Joe Jacoby — Defense Field Marshal.

The Lammies were unable to do any wrong the entire afternoon. Both on the field and after the game the pledges conducted themselves as gentlemen. Combining an invincible spirit and superb ability, the Pledge Class of 1972 brought our most treasured trophy back where it belongs.

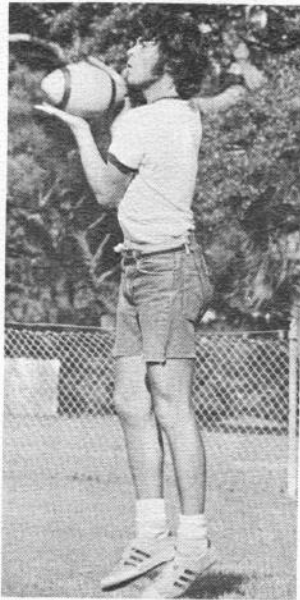
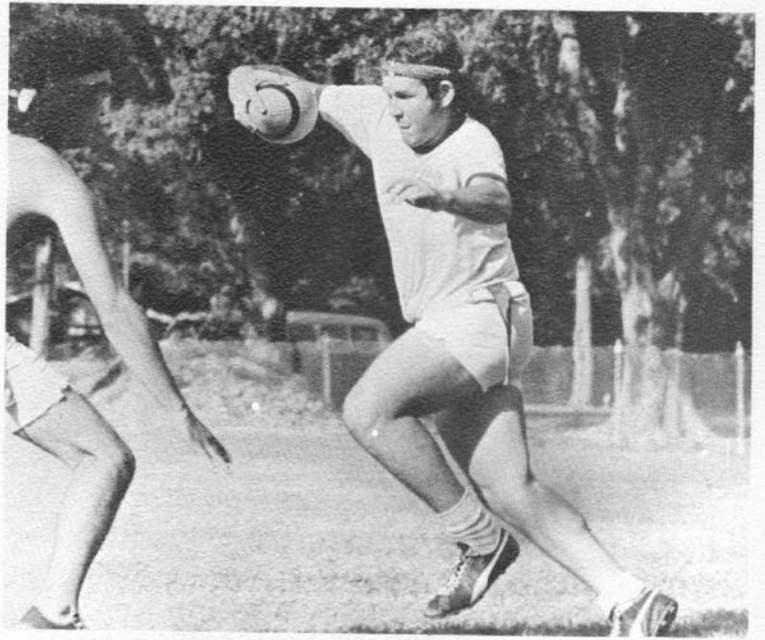

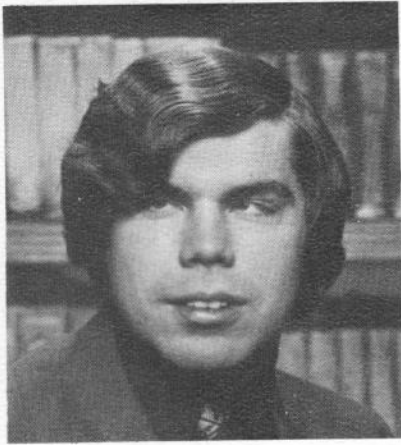

## OUTSTANDING SENIOR

### Roger Wenner

For the graduating brother, no higher tribute can be given him than the honor of being named "Best Senior." This year the award is bestowed on Roger Wenner.

Unlike some past recipients of the award, Roger held no major position in the house. Yet his unswerving devotion to the ideals of the fraternity have won the respect of all his brothers. For his efforts in making pledging more meaningful to the new Pi Lams, Roger sacrificed countless hours of his time.

Always a leader in Pi Lam academics, Roger was an inspiration to his brothers. For his selflessness and love for Pi Lam, Roger has been accorded one of our highest honors.

## BEST FRESHMAN

### Josh Rodstein



In choosing the new brother that has best exemplified the ideals of Pi Lambda Phi, the brotherhood is always faced with a difficult decision. This year was no exception, as after most careful thought, the brothers chose Josh Rodstein.

Displaying an eagerness to participate in all aspects of the house, "Gopher" was Vice-President of the pledge class and Co-Chairman of High School Weekend. His spirit and enthusiasm reflect the desires and hopes of the newest brothers for an ever-growing Pi Lambda Phi.



# Seniors Say "So Long"

**RON BLUMSTEIN**  
Union, N. J.; Marketing, Sr. at Large; Football; Handball; Basketball; Turn your headlights on Blummer.

**ALAN EZRIN**  
Miami; Pre-Med; Rush Chairman; Cokeman; Laundryman; Cross-eyed; Way to run Al.

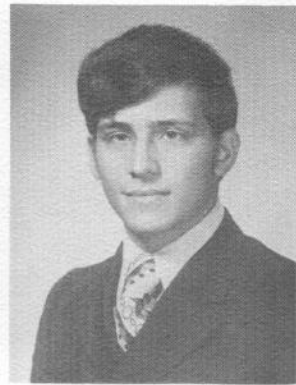

**DAVID GLANTZ**  
Miami; Journalism; Historian; UF Wrestler; Swimming; 8 x 10 Semi-gloss; Sidelong.

**RICK GOLDBERG**  
North Miami Beach; Physical Education; Pearl Weekend Chairman; Athletic Chairman; Graduate at Large; Hocked Up Freshman; Best Sr. Athlete; Nose Bowl Coach; Football, etc.; Rickter.

**MITCHELL HELLER**  
Teaneck, N. J.; Hospital Administration; Football; Basketball; Softball; Handball; Load; Mitchnick.

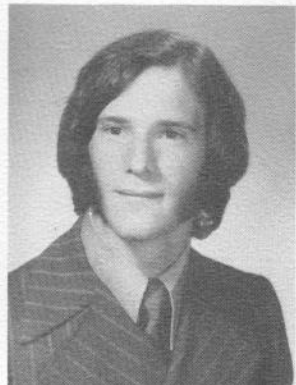
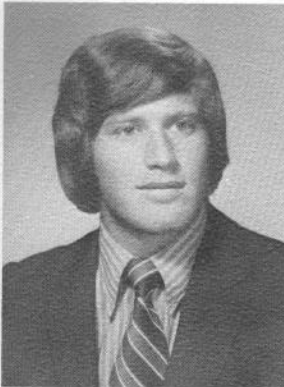

**ANDY LEEFAR**  
Miami; Advertising; Kennedy Homes Project; Pitman; Lived with Rosin.

**LARRY LEWIS**  
Miami; Pre-med; UM Med School; Social Chairman; Soph. at Large; Alumni Chairman; El ToroFeces; Tripod; PSO; Futzin' Lewis.

**BOB MALAND**  
Miami; Advertising; UF Law School; Scribe; Service Chair.; Football; Sock Award; DPhiE Big Brother; Rabbit.

**WAYNE PAASCH**  
Miami; Management; Swimming; Stairjumper.

**MICHAEL PRIMACK**  
Miami; Pharmacy; Treeslap; Man of the House.

**ED SAGER**  
Miami; Pre-Med; Pledge Class Marshall; Football; Handball; Rugby; Pearl Editor.

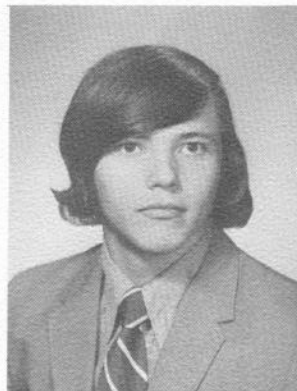
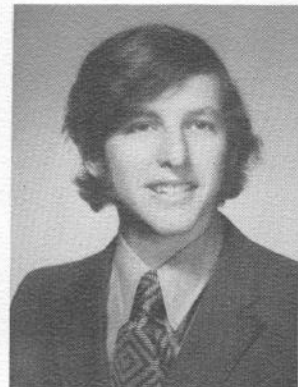
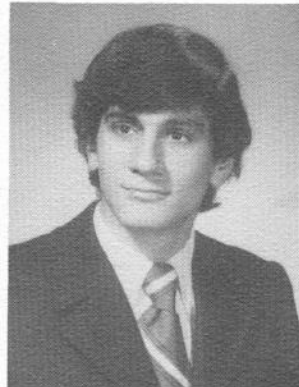

# Seniors Say

## "So Long"

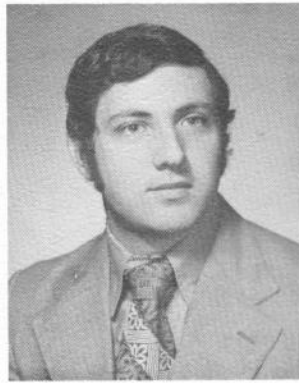

TONY SLAZMAN  
North Miami; Broadcasting;  
Soapy; AEPi Nightwatchman.



ERIC SCHNEIDER  
Hollywood; Advertising; Archon;  
Jr. at Large; Samson; El Toro Feces;  
Bennie; AEPi Guy; father was a  
TKE and sold pencils.



JUAN SOSTHEIM  
Miami; Psychology; Rex; Hand-  
ball; Racquetball; Swimming; Sil-  
ver Saddle; Chico; Aced another  
test.

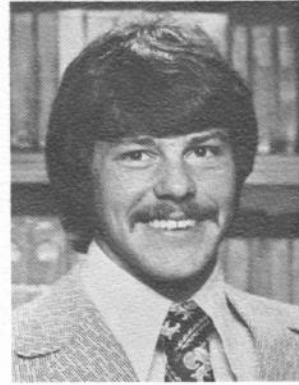

STUART SUSKIN  
Miami; Advertising; Social Chair-  
man; Schroeder; Pookie.

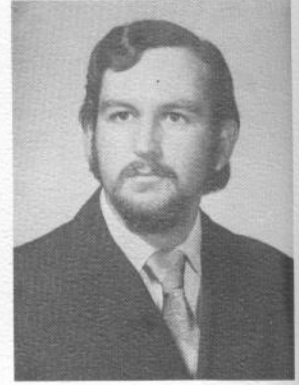

ANDY TEPPERBERG  
Carol City; English; Fox; Ober-  
ferst's friend.



HARVEY KORNSTEIN  
Miami; Political Science; Archon;  
Phi Eta Sigma; Pi Sigma; Pi Sigma  
Alpha; Racquetball Captain; Not 4  
yrs. but three.



PETER CIPORKIN  
Coral Gables; Chemistry; Football;  
Tennis; Volleyball; Softball;  
Hands; Pizz.

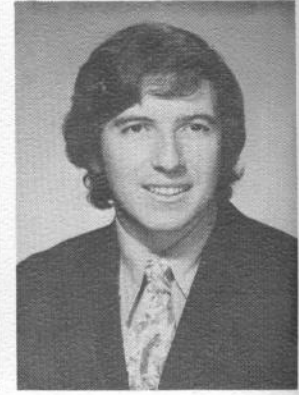

TOM TIBOR  
Coral Gables; Psychology; Golf;  
Hungarian.

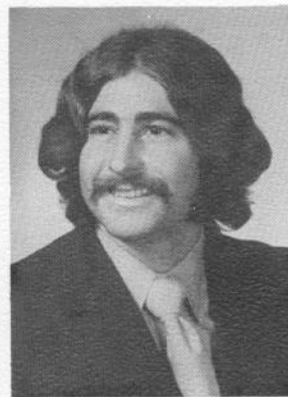

MARSHALL PLATT  
Ft. Lauderdale; Political Science;  
Fat Cat; lived with Dorn.

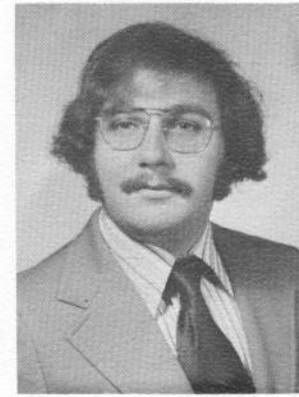

FRANCIS DIGIOVANNI  
Palm Beach; Architecture; Gator  
Greek Cover Design.



ROGER WENNER  
Madera Beach; Accounting; Best  
Sr. Brother; Hell-Master; Phi Eta  
Sigma; Peanut Butter Man; Buzby.

# Seniors Say

## "So Long"

JOHN SMITH  
St. Petersburg; Business; Pledge  
Class KOE; Gator Ray.

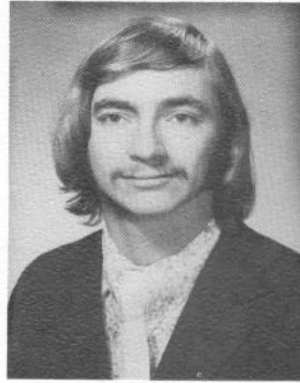

MICHAEL HALPRIN  
Miami; Psychology; Swimming;  
Dog-Man.

GLENN TOBIN  
Tampa; Accounting; Jr. at Large;  
Sr. at Large; Athletic Chair.; Bas-  
ketball Coach; Best Sr. ath.; Coach  
Tobe; Big Boy; Brother of Lee and  
Hams.



### Not Pictured

LEE BESSELL  
N. Miami Beach; History; Pledge  
Class VP; Best Freshman; Lee  
Bessell Wall.

LARRY SAFFER  
Miami; Pre-Med; Pledge Class  
Pres.; Football; Pool-Shark; When I  
won my Nose Bowl.

IRA GORDON  
Miami; Broadcasting; Chaplain;  
ACCENT; WRUF Radio; Gnome;  
Russ Gordon; Voted to Keep Mom  
Dock.

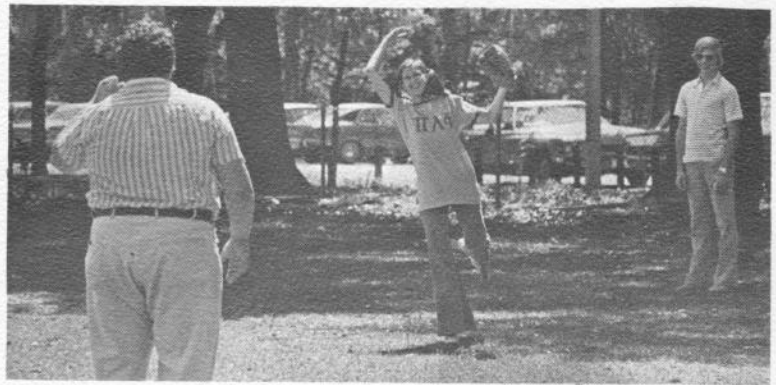
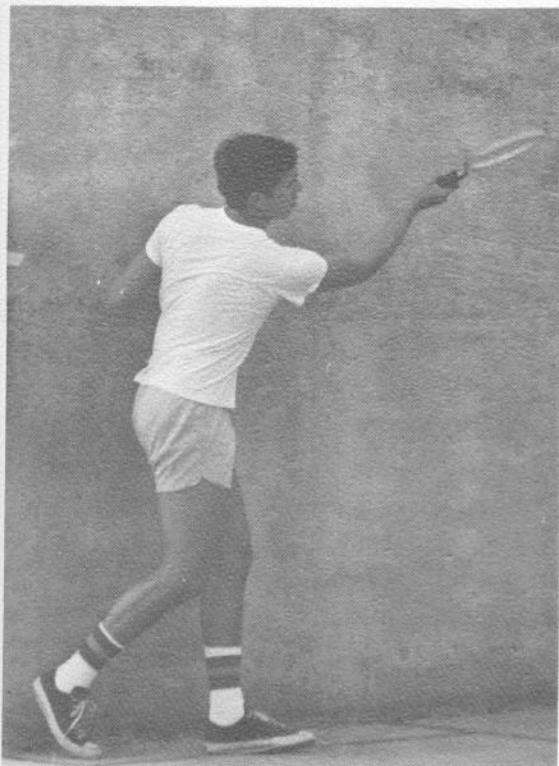





*Bob Klausner*

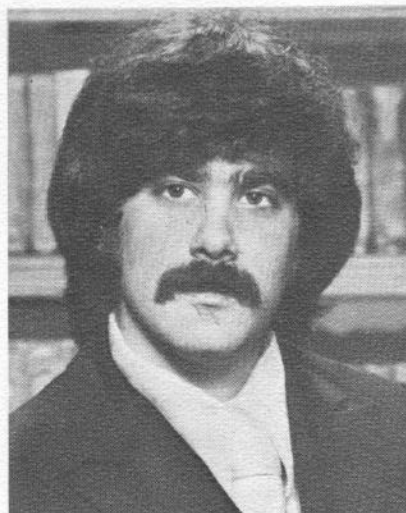

*Richard Blau*

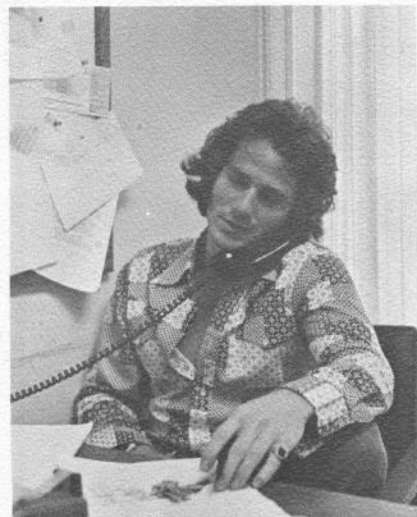

*Jim Elterman*

# PI LAMS:

# THE

For some, involvement in campus affairs is more than mere search for personal gain. Rather it is the expression of a commitment for a better university. It is with such a spirit of concern that finds Pi Lams engaged in countless aspects of student life.

Leading the Pi Lams in the realm of student affairs is Brother Bob Klausner. In November, he was selected by the entire Greek system to be Secretary of the Interfraternity Council. In addition, Bob also served on the Executive Boards of IFC, ACCENT Speakers Symposium, and held a cabinet post in Student Government. In the recent campus elections, Bob was a leader of the New Direction Party and last fall was named to membership in Omicron Delta Kappa Leadership Honorary.

Service to the campus community takes other avenues. Brother Rick Blau continued to provide strong leadership as President of the Pre-Professional Service Organization (PSO). For its numerous hours of volunteer aid to University Health Center, the PSO has gained the respect of the entire staff of the UF Medical College. Brother David Weiner also played an instrumental role in the growth of the PSO.

This years Student Government elections saw three of Pi Lams brothers as successful candidates. In the Senate races Brother Herb Zelikoff was elected from the College of Architecture and Rick Blau earned a seat from the College of Arts and Sciences. Filling out Pi Lams growing political circle is Brother Jeff Hochman who was elected to the Honor Court from the College of Journalism.

# MEN WHO LEAD

In the area of service to the fraternity system, Pi Lams were seen in force. Brother Jim Elterman was named as Director of IFC Frolics and was charged with the task of bringing nationally known entertainment to the campus. In addition, Jim also aided in the co-ordination of publicity for Frolics and Student Government Productions. Brother Gordon Brydger was named to the editorship of the Gator Greek Magaine while Brother Jeff Hochman was IFC Public Relations Chairman. In his role as Rex, Brother Juan Sostheim served on the IFC's Presidents' Council.

Brothers Ira Gordon, Dave Glantz and Tony Salzman were all active in the broadcast team of WRUF Radio. In addition Brother Gordon was a newscaster for WJXT-TV and served as Public Relations Chairman of ACCENT 73. Joel Manis lent many hours of time as a student advisor in the Department of Speech.

Leading the new brothers in the search for a better life for students, is Brother Tony Ozell. Tony served as a campaign manager for the New Director Party in the recent campus elections. In addition, Tony was named to the Interfraternity Council Speakers Bureau. Also lending valuable aid in the SG elections were Brothers Dave Kroner and Don Silver.

It can easily be seen that Pi Lams are actively engaged in all aspects of student involvement. As leaders in campus affairs, they have earned a reputation for great capability and responsibility. Instead of waiting for others to do what needs to be done, Pi Lams are the men that lead.



*Ira Gordon*

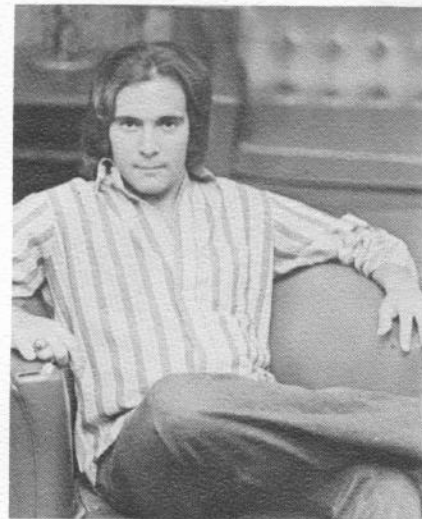

*Jeff Hochman*

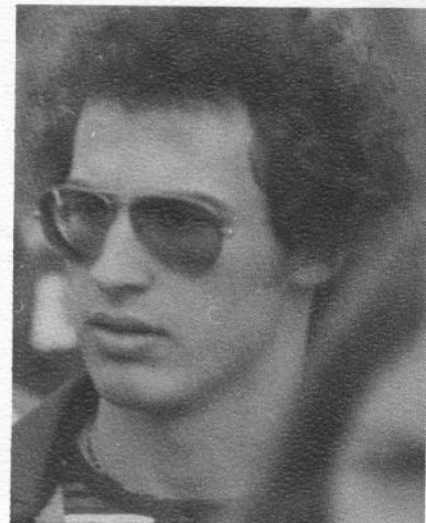

*Tony Ozell*

# OUR GA





# ANG 1973



## Fraternity Songs

### THE PURPLE AND THE GOLD

*(To the Tune of "Coast Guard Marching Song")*

Hail to the Purple and the Gold;  
Long may her colors wave.  
The emblem of Pi Lambda Phi —  
A symbol of her brave  
Mighty in loyalty are we;  
No other love so true.  
We stand with might —  
For all that's right.  
Hail Pi Lambda Phi  
Hail Pi Lambda Phi  
Hail Pi Lambda Phi to you  
—Words by Warren P. Greene

### JOLLY LADDIES

*(To the Tune of "There's a Tavern in the Town")*

We are Jolly Laddies, Jolly Laddies we,  
And firm united is our com-a-ra-de-rie,  
So we'll all join in, to make the wel-kin ring,  
While to Pi Lambda Phi we sing.

So let's join in jolly chorus,  
While our Youth is still before us,  
Let us ev-er joy-ous be,  
Pi Lamb-da Phi in scribed in ev'ry loy-al heart,  
Fra-ter-nal friendship till in death we all do part  
So we'll all join to make the welkin ring,  
While to Pi Lambda Phi we sing.

### BROTHER MINE FOREVER

*(To the Chorus of "Keep the Home Fires Burning")*

*Words by Jack Yellen*

1. Brother mine for-ev-er,  
We are bound to-ge-th-er  
By a bond that stronger grow as years roll by.  
Mystic words un-spok-en  
Ho-ly vows un-brok-en  
Hold us faith-ful to the tie of Pi Lamb-da Phi.
2. When the days are drea-ry  
When the heart grows wear-y  
Tho the dark clouds of des-pair may hide the sky.  
I shall ne-er be friend-less  
For our love is end-less  
Ev-en death can't break the tie of Pi Lamb-da Phi.

# LOVERS AND OT

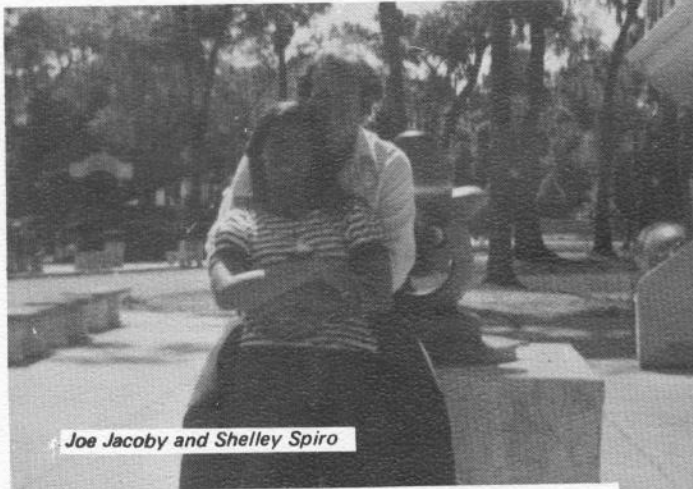

Joe Jacoby and Shelley Spiro



Lesley Liederman & Marshall Platt



Rick Blau & Janice Green

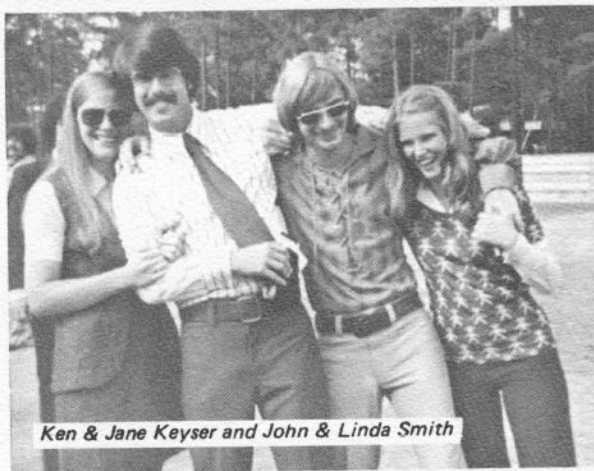

Ken & Jane Keyser and John & Linda Smith



Steve Seidler and Diane Kent

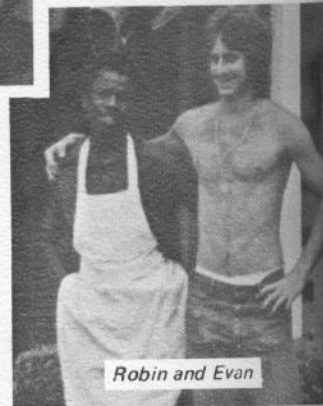

Robin and Evan

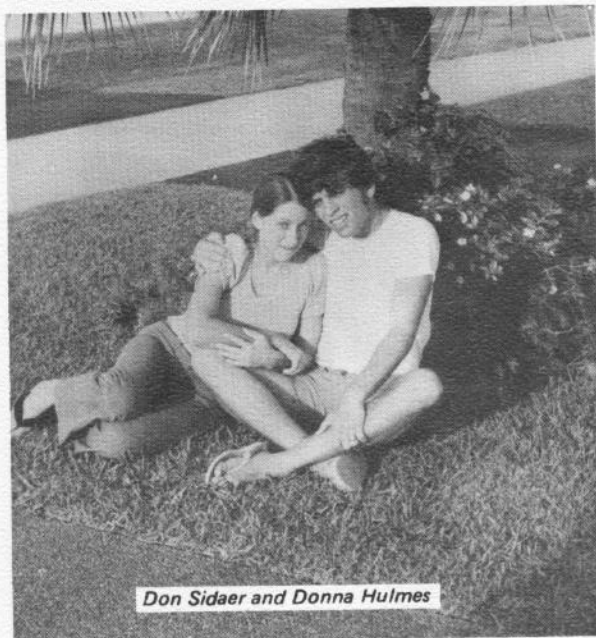

Don Sidaer and Donna Hulmes



Janie Kotzenburg & Howard Sokol



Dave Kroner and Mary Behling



# HER STRANGERS

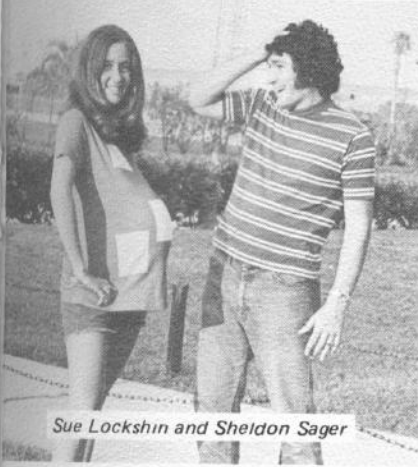

Sue Lockshin and Sheldon Sager

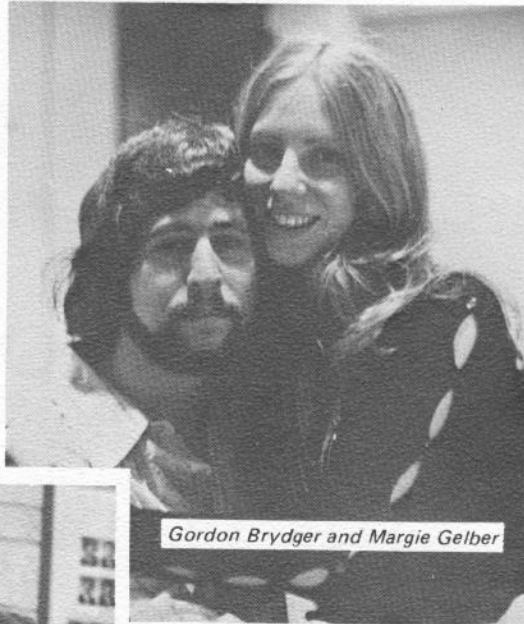

Gordon Brydger and Margie Gelber

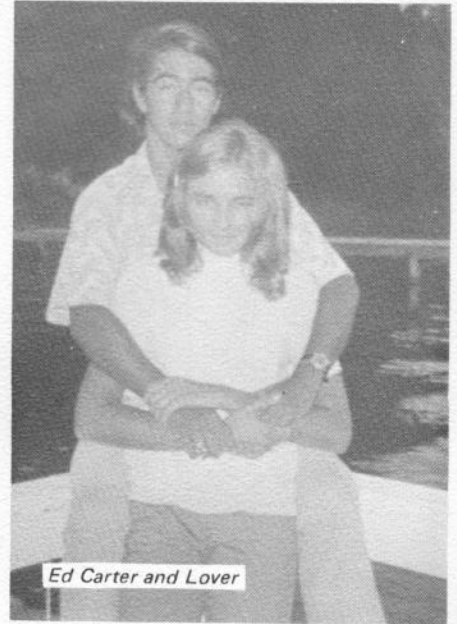

Ed Carter and Lover



Herb Zelikoff and Amy Grant

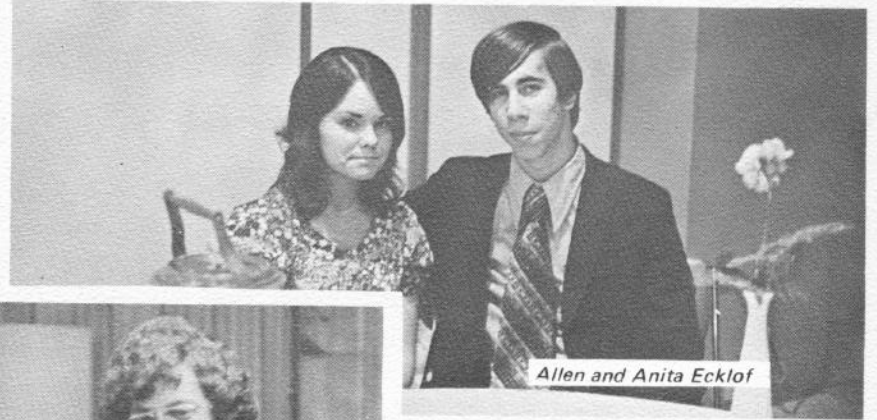

Allen and Anita Ecklof



Jim Elterman and Cassie Funk



Rick Gilman and Laurie Fox

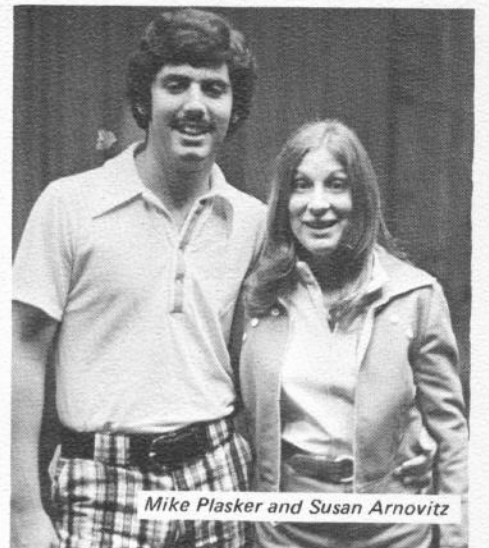

Mike Plasker and Susan Arnovitz





*Rick Gilman*

## LETTER FROM THE PLEDGEMASTER

Dear Rushee,

As a freshman at the University of Florida, you will find that many things are different from high school. The decisions about your education and social life are yours, and they are very important. These early decisions will shape your future.

The University of Florida offers you a fine education. However, education is not confined to the classroom. Pi Lambda Phi offers the fulfillment of your learning experience. We know that college life is a new experience and are constantly trying to achieve the perfect combination of scholastics, social and athletics.

The Pearl explains Pi Lam's brand of fraternalism. I hope you will read it and talk to us about it. Then, as hundreds before you, we can extend an invitation to what Pi Lam fraternity life can offer you.

Sincerely,

A handwritten signature in cursive script that reads "Rick Gilman". The signature is written in dark ink and is positioned above the printed name.

Rick Gilman, Pledgemaster

---

## SUPPORT OUR ADVERTISERS

*To our friends, supporters, patrons, and readers:*

*Without advertising, few organizations can survive. And without those friends and businesses whose funds support the 1973 Pearl, Pi Lam would be no different. Merchants and Pi Lam boosters from New York to Puerto Rico are included in this, the largest volume of advertising in the Pearl's illustrious 18-year history. The Pearl is the oldest, largest and most prestigious fraternity publication on the University of Florida campus. We consider the following merchants both worthy and deserving of your patronage.*

*Remember, they support the Pearl and we support them — We leave the rest to you.*

---

# AUDIOTRONIX

8 WEST UNIVERSITY AVENUE (ABOVE THE BARGAIN MART)  
GAINESVILLE, FLORIDA

Authorized dealer for:

- **Harman Kardon**
- **Citation**
- **Channel Master**

Audio perceptive service on all models. All units sold or serviced are warranted by AUDIOTRONIX





Compliments of



**Horne's**

I-75 at Williston Road  
Phone (904) 378-1511  
Gainesville, Fla.

**Motor Inn**

*Enjoy  
Crown Room Dining  
in the  
Red Baron Lounge*

**& Restaurant**

Look For The Yellow Roof



Your  
University  
City Host



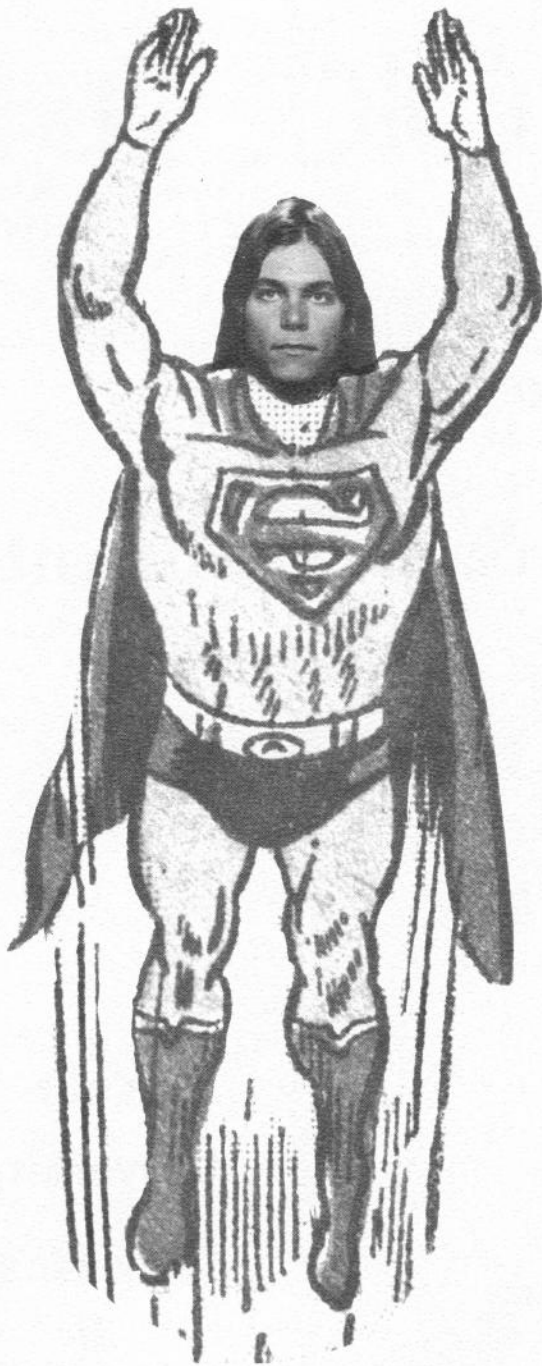

**SUPER**

**CPS Mess**

**says -**

**Thanks For**

**The Use Of**

**The House**

**Again!**

*Now available at*

# KANE CARIBBEAN

The highest quality manufactured

## TRACTORTECNIC

Tractor replacement parts  
for CATERPILLAR  
INTERNATIONAL  
ALLIS CHALMERS  
J. I. CASE  
JOHN DEERE

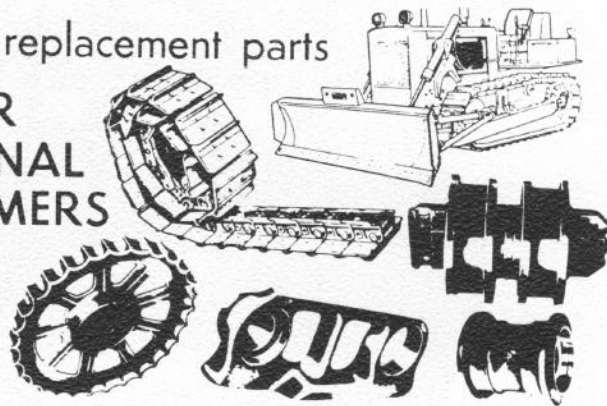

### MIAMI

7601 N.W. 72nd Ave.  
Miami, Florida 33166

Tel. (305) 885-6544

### PUERTO RICO

Bayamón Main Office  
G.P.O. Box 2376  
San Juan, P.R. 00936

Ponce  
Carr. #1 Km. 124  
Esquina Acacia  
Ponce, P.R. 00731

Carr. #2 Km. 17.0  
Tel. 787-3030

Tel. 843-9088



*Best of Luck*  
*in*  
*1973*



*Compliments*

*of*



3321 West University Drive, Gainesville, Florida 32601 Phone (904) 378-3320

**Friends are people who like you . . .**



*Love,  
your friends in AEØ*

*Compliments of*

**MAYOR'S JEWELORS**

Dadeland Mall — Miami, Florida

some try to  
build 'em bigger  
but  
never better

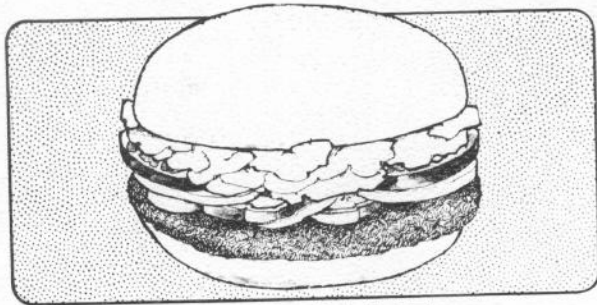

THAN THE  
**WHOPPER**



8 N. W. 16th AVENUE

***NINE LITTLE SISTERS CAN'T BE WRONG!***

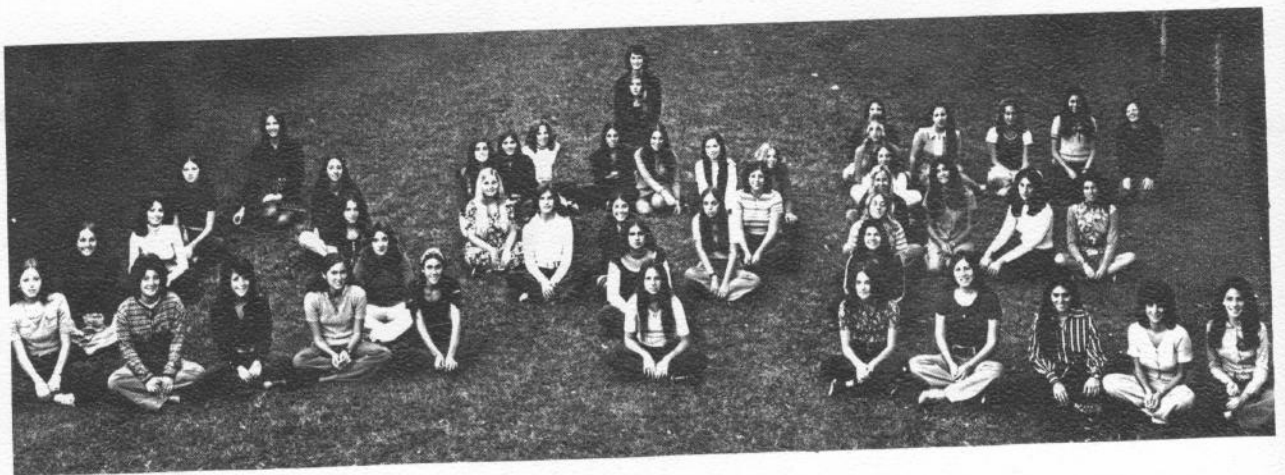

*With Love,*

*Delta Phi Epsilon*



***TOURING-MINDED?***

WHY NOT WITH  
A NEW '73 BMW

Come See Our  
Newest Models

**Griffen's BMW**

615 W. UNIVERSITY AVE.  
PHONE 378-2811

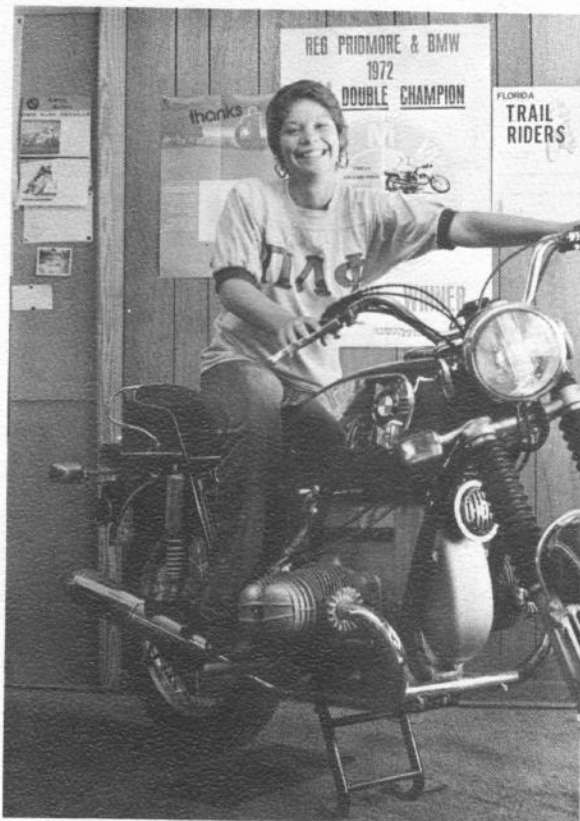

Best of Luck To

TT Λ Ø

from

THE

TREDWELL FAMILY

*All Best Wishes*

***Paul H. Marks, C.K.***

LLB 1930

Florida Delta  
Chapter

e e e-yeah  
Lammies!

THE ZELIKOFFS

## Tom Sawyer Motor Hotel

4029 S. W. 13th STREET

40 ROOMS / Individual Heating & A.C.  
Restaurant / Package Liquor Store  
Swimming Pool / Wading Pool



JUICE BAR & TRADING CO.  
*NOW OPEN*

with Juices, Soups, Sandwiches,  
Hot Sandwiches & Natural Foods  
*plus*  
HANDMADE & IMPORTED CLOTHING  
1017 WEST UNIVERSITY AVENUE

# GRAND CENTRAL STATION

MEN & WOMEN

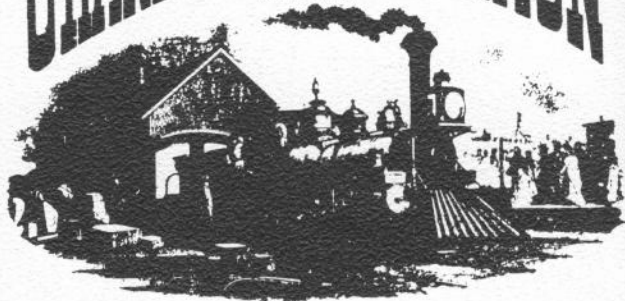

MIAMI  
Midway Mall  
261-1973

CORAL GABLES  
78 Miracle Mile  
444-6632

GAINESVILLE  
1019 W. University Ave.  
373-5075

# Love for Sale

*Owned & Managed by J. T. Cruikshank*

**FRESH & SALT WATER FISH  
AQUARIUMS & SUPPLIES  
AQUATIC PLANTS**

**Birds — Reptiles — Registered Dogs  
Small Mammals  
Si Supplies for All**

**Distinctive Grooming  
for All Breeds**



**GAINESVILLE  
SHOPPING  
CENTER**

1218 N. Main Street

**372-7387**

## ZIPP SPORTING GOODS

5734 Sunset Drive, Miami  
7230 Red Road, Miami, Florida  
(305) 665-3534

**18 Years in Miami Fulfilling South Florida's  
Sporting Goods and Sports Wear Needs**

*Complete Line of Equipment for All Sports*

- Tennis Racket Stringing — 2 Hour Service
- Girls and Mens Gym Wear
- Top Line Sports Shoes — Adidas & Others
- Brunswick Bowling Equipment and Accessories

Headquarters for the University



## University Inn

101 Rooms—All major Credit Cards Honored

*V.I.P. SUITES AND 2 FINE RESTAURANTS*

### HAWAIIAN ROOM

*"Hawaii in Gainesville"*

### POLYNESIAN LUAU

All You can Eat: Luncheon \$1.95

### SUNDAY: "AROUND THE WORLD BUFFET"

All You can Eat: Dinner \$2.95

### BARTKES STEAK ROOM

*"Elegance in Leisurely Dining"*

St. Petersburg, Tampa — Now in Gainesville

### WAHINE LOUNGE

Bobby Griffen Entertaining Nightly

*Come in and See our Velvet Wahines'*

**UNDER NEW OWNERSHIP & MANAGEMENT**

*— Irving Turk, Proprietor*

**GET YOUR BOOKS  
AND SUPPLIES ON CAMPUS  
AND SAVE!!**

AT THE HUB — — With branches in:

Medical Center

Broward

Towers

Union

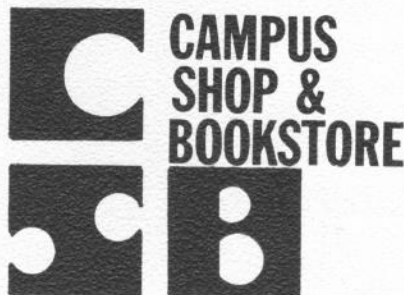



—Real Pit Bar-B-Q—

Sonny's

# FAT BOY'S BAR-B-Q



Phone 378-5161  
2700 Waldo Road

Phone 373-3339  
3610 S.W. 13th Street

Gainesville, Florida 32601

## YOU LOOK BETTER WITH TASCO

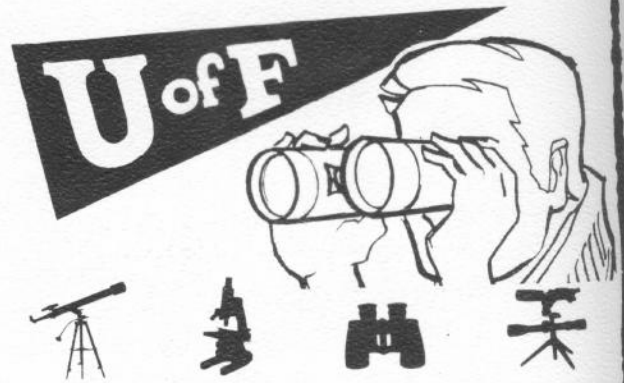

In every field of optics—microscopes and accessories for school and professional use, telescopes for general and astronomical use, binoculars for sports and field viewing, riflescopes for pinpoint shooting—Tasco invites critical comparison. You can spend a lot more...but you can't buy any better!



# tasco®

1075 N.W. 71st Street, Miami, Florida 33138

*When that special  
occasion calls for  
formal attire...  
why not rent?*

The tuxedo you wear has a lot to say about you, and this superb Palm Beach\* tux says all the right things. With luxuriously braided velvet lapels, slanted flap pockets, fitted waist—a truly distinctive tuxedo that stands out from the crowd. It's just one from our distinguished collection of Palm Beach formal fashions available for rental.



## Formal Fashions of Gainesville

1007 W. University Ave., Gainesville, Fla. 32601  
(904) 373-3306

# Crosby's

GULF SERVICE



- TIRES
- BATTERIES
- MUFFLERS
- BRAKES
- ACCESORIES

ROAD SERVICE  
MINOR TUNE-UP  
and REPAIRS

MECHANIC ON DUTY  
AUTO AIR CONDITIONING SERVICE

Gainesville's Most Complete Service Center

372-9374

931 W. UNIVERSITY AVE.



*Best Wishes*



## The University Shop

AMERICA'S DISTINCTIVE  
FASHIONS FOR  
MEN AND WOMEN

In the University Plaza  
at 1620 West University Avenue

## GRADY CABINET WORKS

Tom W. Grady, Owner  
SPECIAL and CUSTOM MADE  
MILLWORK – SPRAY PAINTING

PHONE FR 2-8312

1529 SOUTH MAIN STREET  
GAINESVILLE, FLORIDA

“ PADDLES CUSTOM-MADE ”

*Best Wishes*

*from*

BYRON  
&  
DOROTHY  
SALTER

*Little*

*Larry's*

Restaurant

Famous For Our  
**He-Man Breakfast**  
**\$1.20**

2 Eggs – 2 Hot Cakes – Choice of Meat  
Grits – Toast and Coffee

1225 WEST UNIVERSITY AVENUE  
Just ½ Block from Campus

*Best Wishes*

*from*

**THE  
BENJAMIN  
FAMILY**

*Compliments of*

**THE  
ARNOVITZ  
FAMILY**



306 N. W. 13th STREET



**Home of The  
World's Best  
Hamburger**

2 LOCATIONS TO BETTER SERVE YOU!  
1802 W. University - 1430 S.W. 13th St.

**Best Wishes**

**to**

**Pi Lam**

**from**

**ECKLOF FAMILY**

*Bushwackers*



*distinctive haircutting*

109 n. main street  
phone 313-2717



*Best of Luck Pi Lams*

**The Kornstein Family**

*Best Wishes from*



**Bambi Motel**

2119 S.W. 13th Street Gainesville, Florida  
Telephone: 376-2622

FUMER

FOR THE FINEST IN

Headgear

OPEN MON. – SAT.  
10:30 – 5:00

*“Pi Lambda Phi inscribed  
in every loyal heart . . .”*

*As it is in ours – best wishes*

*Carla & Russell Klepper*

Compliments of



GATOR SHOP

1710 West University Avenue

*Best Wishes to*

TTΛØ

**The Klausner Family**  
**Jacksonville, Florida**

PHONE: 904 / 372-0577

24 HOUR SERVICE

## *Bar-Stell*

games, photographs and cigarette machines  
"GERMAN FOOTBALL" MACHINES

AMUSEMENT AND VENDING, INC.

814 N.W. 4TH STREET  
GAINESVILLE, FLORIDA

*Compliments of*

## SHAKLEE

## DISTRIBUTORS

## THE WEARHOUSE

*SPECIALIZING IN FRATERNITY  
SPORTSWEAR AND FAVORS*

1129 W. University  
378-1033

*At the Gainesville Mall?*

*VISIT THE*

## KORN KETTLE

*Candy - Ice Cream - Drinks*

376-1370

*From UF Class Rings  
to Wedding Rings*

## Rutherford's Jewelers

Gainesville's Quality Jewelers

In The Gainesville Mall



376-4431

*Best Wishes from*

## Al's Barber Shop

1144 N.E. 16th Ave.  
378-4281

# SHELLEY'S

NOW WITH 2 LOCATIONS

1608 N. W. 1st Ave. — 378-1628

*Take Out Delivery*

3469 S. W. Archer Rd. — 372-6582

*Dine In — Delivery*

## Wombles Standard Oil Service Station

WALDO RD. & N.E. 16th AVE.

372-9337

Gainesville, Florida



*"Fast, Friendly Service"*

## McCollum Drug Company

2 LOCATION TO SERVE YOU

1 124 W. University Avenue

1324 E. University Avenue

## Public Radio & Electronics

- Stereos
- Tape Recorder
- Auto Radio & Players
- Parts

MASTER CHARGE & HFC

Call 378-1524

101 Southeast 1st Street

Gainesville, Florida



PHONE 373-8247

## Bob Davis & Sons

SPECIALIZING IN

### VOLKSWAGEN

SERVICE & REPAIRS

12 Years Exclusive VW Experience

2027 N.E. 27th Ave. Gainesville, Fla. 32601

*Best Wishes to Pi Lam*

from the

## Schneider Family

Best Wishes from

## University Cigar & Newsstand

18 W. University Ave.

Phone 372-8831



## Silvermans

*Desirable Apparel for Men and Women*



*Visit our Ladies  
Mezzanine &  
Browse in our  
"Wonderful  
World of  
Fashion"*

Hart-Schaffner & Marx  
Johnny Carson — Kingridge  
Hathaway & Manhattan Shirts  
Bostonian Shoes  
& Many Other Brands

225 W. Univ. Ave.

378-1611



*Compliments of*  
**DONZI MARINE  
INC.**

*MIAMI, FLORIDA*

*Best Wishes*

*to*

*Pi Lam*

*from*

**THE GILMAN FAMILY**

**Eveready Pest  
Control  
Service**

*OF MIAMI*

*Good Luck to*

*The Lammies*

*from*

**Steven Aradi Painting  
Corp.**

*Best Wishes*

*from*

*The Jackson Family*

**McGuire Trophy & Engraving**

SPECIALIZING IN

Trophies  
Engraving  
Signs  
Name Tags

Jersey Lettering  
Desk-Plaques  
Lavaliers & University Charms  
Customer designed paddles to stampout

1706 W. University Avenue, Gainesville, Florida 32601  
"Complete Service Shoppe"

Bill McGuire Pres.

BUS. 378-8585  
HOME 376-8135

*COMPLIMENTS OF*

**H & Y CAR WASH**

303 N. W. 13th Street  
Gainesville  
(2 Blocks North of UF)

*The Merc & The Goph say:*

**17-0 The DOLPHINS  
are perfectly  
SUPER!**

MICHAEL J. WASSERMAN

**CABLE/COLOR**

**- DIVISION OF WASSERMAN ELECTRONICS -**

6421 S.W. 41 STREET MIAMI, FLORIDA 33155

665-3247

# GRESHAM'S DRUGS

*"PROFESSIONALLY YOURS SINCE 1953"*

GRESHAM DRUG STORE  
372-2558  
3333 S.W. ARCHER ROAD

THIRTEENTH PHARMACY  
376-2668  
1522 NORTHWEST 13TH ST.

GRESHAM'S PRESCRIPTION CENTER  
372-4202  
815 SOUTHWEST 4TH AVENUE

GRESHAM'S 16TH DRUGS  
376-2568  
1605 SOUTHWEST 13TH ST.

GRESHAM'S NORTHGATE DRUGS  
372-8431  
1138 NORTHEAST 16TH AVENUE

## GO PI LAM!

### Best of Luck Always -

FRATERNALLY,  
CHARLIE, SAUS, DUDE, CRICKET-'68  
THE BERG - '69 TUCK - '70

*The New Signet Class Ring for Men*



THE TRADITIONAL  
ALLIGATOR RING  
ALSO AVAILABLE  
AT

*Robertson*  
JEWELERS



A. & J. SAW and MOWER Co.  
1944 N.E. 23RD BLVD.  
372-3588  
GAINESVILLE, FLORIDA

HOMELITE CHAIN SAWS - GRAVELY TRACTORS

JOE ANDERSON, OWNER

DON MCNEAL

*Best Wishes  
in 1973 to*

## PI LAMBDA PHI

### The Trach Family

NORTH MIAMI, FLORIDA

## Compliments

of

## THE ALTERMANS

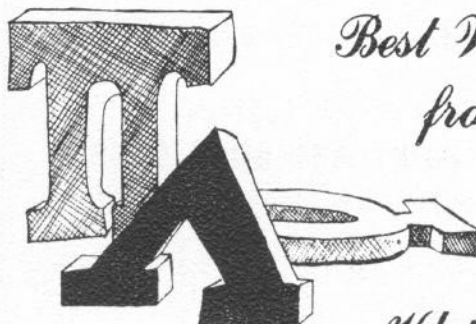

*Best Wishes  
from*

*The  
Kleinbergs*

*Best Wishes*

*and*

*Good Luck*

*in '73*

*The*

*Sostheims*

*Compliments*

*of*

**THE  
ROPHIE  
FAMILY**

# THE HARTLEY PRESS

4250 St. Augustine Road / Jacksonville, Fla. 32217

Phone 398-5141

- STATIONERY
- CHECKS
- SNAP-OUT FORMS
- PROGRAMS
- BROCHURES
- WEDDING INVITATIONS

*Fast Service / Reasonable Prices*

(We printed THE PEARL)



PHONE 376-9216

**JOHNSON'S PRODUCE CO.**

214 N.E. 16TH AVENUE  
GAINESVILLE, FLORIDA 32601

ANDY JOHNSON, JR., OWNER      WHOLESALE & RETAIL

WE GUARANTEE OUR WORK

**JOY'S PAINT AND BODY SHOP**

YOU'LL FIND US A "JOY" TO DO BUSINESS WITH

PHONE 373-1665

2604 N.E. 19TH DRIVE  
GAINESVILLE, FLORIDA

*Best  
Wishes  
from*

*the*

**Smilovitch**

**Family**

bill pinner  
footwear



*Best Wishes*  
*from*  
**THE JACOBI FAMILY**

**LITTLE PROFESSOR  
BOOK CENTERS**

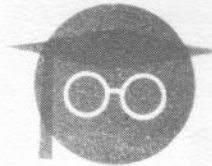

1310 W. University Ave.  
378-0363

**Unclaimed Freight**

Sales & Service

Bedding — Stereos — Furniture  
Carpets — 8 Tracks

107 S. E. 1st

BUY - SELL - TRADE



**Antique Emporium**

924 N.W. 4TH STREET  
GAINESVILLE, FLORIDA 32601  
PHONE (904) 373-1996

RUTH AND AL DAVIS

*Best Wishes*  
*from the*  
**Modern  
Shoe Repair Shops**

1820 W. University  
&  
101 N. Main Street

**Compliments of**  
Herman and  
Judy Paul  
and  
Michel & Steven



*"Spend the Night  
Where the Price is Right"*



WELCOME TO  
**GATOR COURT**  
  
**MOTEL**

- COLOR TELEVISION
- CABLE T.V. ROOM PHONES

HOSTS — LILLIAN AND GEORGE SCHASER

4170 S.W. 13TH STREET • GAINESVILLE, FLA. 32601  
PHONE 376-4667 OR 376-4668

**Best of Luck  
to ΠΛΘ  
THE TOBINS**

HARRIS, GLENN, LEE and PENNY

SPECIALIZING IN ELECTRICAL TUNE-UP  
& AIR-CONDITIONING

## KELLY'S UNIVERSITY SHELL

215 N.W. 13th Street / Gainesville, Florida 32601

JOHNNY KELLY, OWNER

# Avis

CALL 376-8114

CALL 378-0161



*WE RENT MOST ANYTHING*

CONTRACTORS - INVALID - HOMEOWNERS  
PARTY BANQUET - AUDIO-VISUAL TV  
MAINTENANCE EQUIPMENT

220 N. W. 8TH AVE.

372-9541

## Best Wishes

from

## The Lawrence Family

## College Inn Cafeteria

1728 West University Ave.

TAKE A STUDY BREAK  
PLAY FOOSBALL & PINBALL  
PLENTY OF SNACKS

*FEEDING GATORS SINCE 1914*

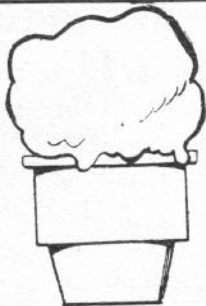

## Baskin Robbins

- Ice Cream Cakes
- Malts & Shakes
- Sundaes & Banana Splits
- 31 Delicious Flavors



Baskin-Robbins

Ice Cream

1724 W. Univ. Ave.

## Bohanon's Enco

*SPECIALIZING IN:*

- \* TUNE-UPS & BRAKE WORK
- \* 3 EXPERIENCED MECHANICS
- \* FRONT-END ALIGNMENT & BALANCING
- \* FREE TOWING WITH REPAIRS

## Compliments of

## THE FORMAN FAMILY

*Always Serving You*

## Wilberts Grocery

ACROSS FROM THE LAW SCHOOL

Wilbert Langston, Owner

Regards from

The

Aaronson Family



And remember we offer a complete line of ushers' and men's gifts

YOUR DAY TO REMEMBER  
The Godfather Look

Mitchell's TUXEDO RENTALS AND SALES  
GAINESVILLE  
714 W. University Avenue  
located directly across from Santa Fe Jr. College.  
Telephone 376-2561 or 376-7612

Charlie's

AUTO GLASS

- \* Auto-Truck-Fleet Work
- \* Insurance Jobs
- \* Wholesale & Export
- \* Water Leaks Sealed

7070 S. W. 12 Street / Miami, Fla. 33144  
261-6062

Rock Em Sock Em PILAMI  
Come SEE  
1636 WEST UNIVERSITY AVE. UPSTAIRS  
Books, HERBS AND IMPORTS - FROM ALL OVER THE WORLD

Best Wishes

From

Dr. Fred Brown

Pledge Class of "72"

Best Wishes to Florida Delta



GEORGE BECK

National Executive Secretary

FAGAN'S SURPLUS

116 S.W. 1st AVE. - (Downtown)

FEATURES

- White Stag Camping Equipment
- Seafarer Navy-Bell Jeans
- Novelty Jeans
- Over-alls
- Hiking boots
- Back Packs for Camping or Books

Malone's

BOOK & SUPPLY, INC.

1702 N. University Ave. / Gainesville, Fla.



"THE MUSIC  
PEOPLE"



24 HOURS A DAY

*Compliments  
of  
Attorney  
General  
and Mrs.  
Robert  
Shevin*

*Best  
Wishes  
from*

**CHULA'S  
FAMILY**

**Colonial  
Flowers**  
INC.

FLOWERS - CANDIES - GIFTS  
FOR ALL OCCASIONS

372-5775  
372-5349

1220 West University Avenue  
Gainesville, Florida

CONGRATULATIONS  
TO  
PI LAMBDA PHI  
from

**Mr. & Mrs.  
Leon Darlow  
&  
Mark Darlow**

**Pledge Class  
of 1967**

*Compliments  
of*

**GEORGE  
BRADY**

**H. S. Camp  
& Sons**

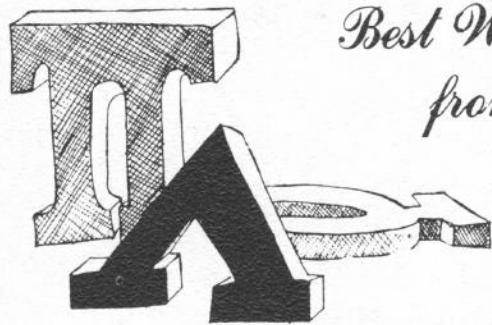

*Best Wishes  
from*

*The  
Gelbers*

**Pizza Train and  
Rapp's Delicatessen**

ENTERTAINMENT ON WEEKENDS  
1515 S. W. 13th Street\*  
Seating for 75 - Catering - Delivery  
Phone 373-3377 or 376-3354

PIZZA

BEER

**"ENJOY"**

# PEOPLE. . .

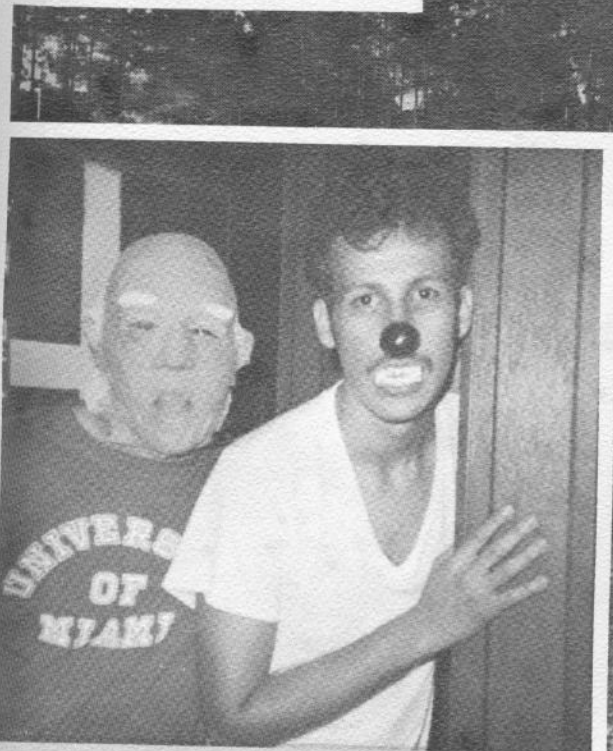
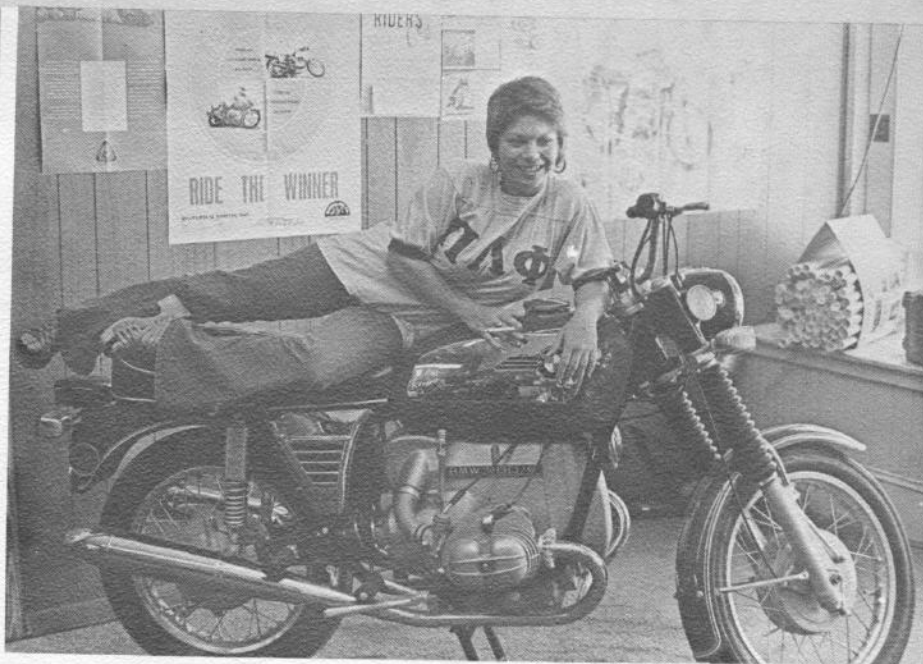

# MORE PEOPLE . . .

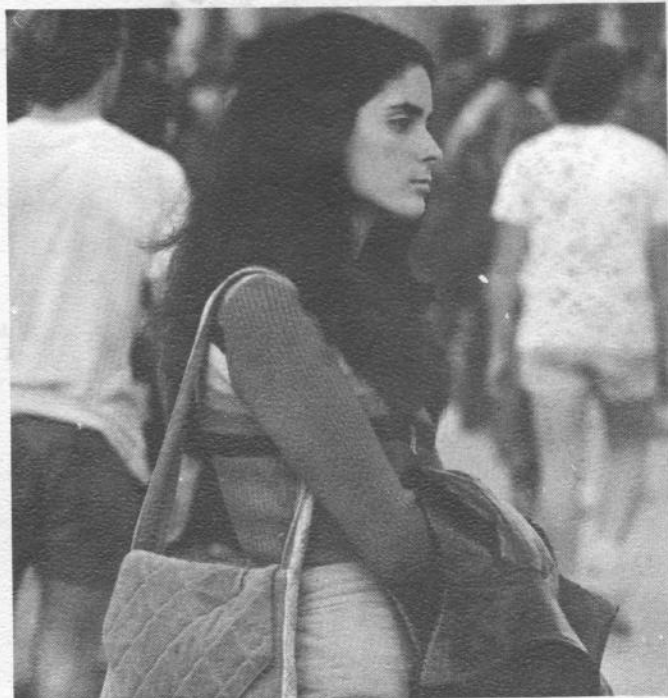



# PI LAM ROSTER

REX – Juan Sostheim  
 ARCHON – David Tillis  
 KOE – Stephen Seidler  
 SCRIBE – Robert Klausner  
 PLEDGEMASTER – Richard Gilman  
 MARSHALL – Jeffrey Hochman

CHAPLAIN – Michael Plasker  
 SOCIAL CHAIRMAN – Joseph Jacoby  
 HISTORIAN – Edward Soloman  
 SENIOR AT LARGE – Glen Tobin  
 JUNIOR AT LARGE – Peter Curreri  
 SOPHOMORE AT LARGE – David Stein

Daniel Aaronson, Ft. Lee, N. J.  
 Rick Adelman, Columbia S.C.  
 Victor Alonso, Miami  
 Edward Alterman, Palatka  
 George Aradi, Miami  
 Nick Aradi, Miami  
 Leon Azis, Raleigh, N. C.  
 James Benjamin, Miami  
 Richard Blau, North Miami  
 Ron Blumstein, Union, N. J.  
 Robert Bogen, Columbia, S. C.  
 Gordon Brydger, Miami  
 Evan Byer, North Miami Beach  
 Edward Carter, Daytona Beach  
 Sandy Chisholm, Hallandale  
 Peter Ciporkin, Miami  
 Peter Curreri, Hollywood  
 Mark Darlow, Miami  
 Steve Diamond, North Miami Beach  
 Francis DiGiovanni, Palm Beach  
 Allen Ecklof, Jacksonville  
 James Elterman, North Miami Beach  
 Howard Farbish, Miami  
 Roland Farris, Jacksonville  
 Joseph Fisher, Coral Gables  
 Mitchell Fishkind, Miami  
 Terry Forman, Miami  
 Richard Gilman, Miami  
 Michael Give' Miami  
 David Glantz, Miami  
 Richard Goldberg, North Miami Beach  
 Ira Gordon, Miami  
 Marc Grey, Miami  
 Stanley Halpern, Jacksonville

Michael Halprin, Miami  
 Jeff Hirsch, Miami Beach  
 Mitchel Heller, Teaneck, N. J.  
 Jeffrey Hochman, Miami  
 Joseph Jacoby, Miami  
 Dean Kane, San Juan, P. R.  
 Dennis Kay, Cohasset, Mass.  
 Ken Keyser, Gainesville  
 Robert Klausner, Jacksonville  
 Bruce Kleinberg, Miami Beach  
 Harvey Kornstein, Miami  
 David Kroner, Hallandale  
 Dennis LaRoche, Pensacola  
 William Lawrence, Jacksonville  
 George Lipp, Jacksonville  
 Louis Lippman, Miami  
 Scott Lyons, Coral Gables  
 Robert Maland, Miami  
 Joel Manis, Miami Beach  
 Steven Maxwell, Miami  
 Robert Merlin, North Miami Beach  
 Steve Messing, Coral Gables  
 Joel Meyer, Miami  
 Barry Meyerson, North Miami Beach  
 Mark Michelson, Jacksonville  
 Charles Modell, Gainesville  
 Keith Nelson, Miami  
 Tony Ozell, Jacksonville  
 Wayne Paasch, Miami  
 Michael Plasker, Hollywood  
 Marshall Platt, Miami  
 Josh Rodstein, North Miami Beach  
 Alan Rophie, Clearwater  
 Thomas Rosenfield, Clanton, Ala.  
 Michael Rosin, Sarasota

Stuart Sacks, Miami  
 Edward Sager, Miami  
 Sheldon Sager, Miami  
 Tony Salzman, Miami  
 Jan Saulson, Miami Beach  
 Robert Schack, Miami  
 Flip Schemer, Miami  
 Eric Schneider, Hollywood  
 Gary Schuler, Miami  
 Barry Sedlik, Miami  
 Stephen Seidler, Miami  
 Donald Silver, Miami  
 Samuel Slom, Jacksonville  
 John Smith, St. Petersburg  
 Harold Smilovitch, Miami  
 Howard Sokol, Miami  
 Edward Solomon, Miami  
 Juan Sostheim, Miami  
 Alan Stein, Miami  
 David Stein, Hollywood  
 Stephen Sultanoff, Hallandale  
 Stuart Suskin, Coral Gables  
 Thomas Tibor, Miami  
 David Tillis, Jacksonville  
 Glenn Tobin, Tampa  
 Lee Tobin, Tampa  
 Mark Trach, Miami  
 James Tredwell, Miami  
 Edward Wacks, Miami  
 David Weiner, Miami  
 Roger Wenner, Madiera Beach  
 Mark Whitehouse, Miami  
 Herb Zelikoff, Miami



# ***We Always Look Back With Pleasure on our Days as Brothers of Pi Lambda Phi***

## **Dade Federal Savings & Loan Association of Miami**

101 East Flagler Street, Miami  
Charter #72 in the U. S. A. (1933)  
*Assets over 500 Million*

Joseph I. Lipton, Chairman  
Pennsylvania, B. S. B. A. 1722

## **Financial Federal Savings & Loan Association**

401 Lincoln Road, Miami Beach  
Charter #2 in the U. S. A.  
*Assets over 500 Million*

Leo Rose, Florida Delta, AB, LL.B. 1939  
Counsel-Meyer, Weiss, Rose & Arkin

## **Washington Federal Savings & Loan Association of Miami Beach**

1701 Meridian Avenue, Miami Beach  
*Assets over 400 Million*

Arthur H. Courshon, Chairman of Board  
Florida Delta; BA 1942; LL.B. 1948  
Milton M. Gaynor, Vice President  
Florida Delta; BA 1939

## **Flagler Federal Savings & Loan Association of Miami**

101 N. E. First Avenue  
*Assets over 200 Million*  
Paul H. Marks, Chairman of Board  
Florida Delta, LL.B. 1930  
Seymour D. Keith, Vice President  
Florida Delta and Omega Eta; LL.B. 1947  
Herschel Rosenthal, Executive  
Vice President  
Omega Eta; BA 1949

## **Biscayne Federal Savings & Loan Association in Miami**

1790 Biscayne Boulevard, Miami  
*Assets over 200 Million*  
E. Albert Pallot, President  
Florida Delta; (Honorary 1950)

## **Highlands County Savings & Loan Association of Sebring**

Stanley H. Davis, President  
Florida Delta; BS 1941

## **Charlotte Federal Savings & Loan Association**

Punta Gorda, Florida  
Leo Wotitsky, President  
Florida Delta, 1933 BS ED  
Florida Delta LL.B. 1953

## **First Federal Savings of Nassau County**

Fernandina Beach  
Herbert W. Fishler, President  
Florida Delta; LL.B. 1930

## **Jefferson National Bank Of Miami Beach**

301 Arthur Godfrey Road, M. B.  
*Assets over 65 million*  
Arthur H. Courshon, Chairman of Board  
Florida Delta; BA 1942; LL.B. 1948  
Milton M. Gaynor, Director  
Florida Delta, BA 1939  
Jack R. Courshon, Director  
Florida Delta; BA 1943; LL.B. 1948

## **International Bank of Miami**

627 SW 27th Avenue  
*Assets over 60 million*  
Richard A. Pallot, President  
Florida Delta; LL.B. 1956  
Judge Sam I. Silver, Counsel  
Florida Delta; LL.B. 1937  
Edward A. Stern, Counsel  
Florida Delta; LL.B. 1955